

N°	Doc. Number	Titolo	Title	Q.tà	N°	Doc. Number	Titolo	Title	Q.tà
1	X02.408.000	RACCORDO DRITTO PER OCCHIO 1/4"	JACK EYE RIGHT UNION 1/4"	6	43	X50.231.000	TUBO DI ANCORAGGIO	ANCHOR TUBE	2
2	X02.471.000	OCCHIO 1/4" PER MARTINETTO	JACK EYE 1/4"	2	44	X50.232.000	TIRANTE DI SOSTEGNO SINISTRO	LEFT TIE-ROD	1
3	X02.472.000	RONDELLA DI RAME Ø 19x13,5x1,5	COPPER WASHER Ø 19x13,5x1,5	24	45	X50.232.100	TIRANTE DI SOSTEGNO DESTRO	RIGHT TIE-ROD	1
4	X02.838.201C(DX)	MARTINETTO COMPLETO CORSA L=156	COMPLETE JACK	2	46	XD0.10.5587G	DADO M10 6S PG 5587 ZINC.	M10 6S BIG LEAD NUT 5587	22
5	X02.838.201C(SX)	MARTINETTO COMPLETO CORSA L=156	COMPLETE JACK	2	47	XD0.12.5587G	DADO M12 PG UNI 5587	M12 NUT	44
6	X02.986.002	SEMI FASCETTA SEMPLICE D.175 CON DADO M10	HALF CLAMP WITH NUT M10	2	48	XD0.20.5589G	DADO BASSO M20	LOWER NUT M20	20
7	X02.986.102	SEMI FASCETTA SEMPLICE D.175 CON ANELLO	HALF CLAMP	2	49	XDA.008.0AG	DADO AUTOBLOCCANTE M8 ALTO PG ZINC.	HIGH BIG LEAD M8 SELFLOCKING	5
8	X20.718.000	REGOLATORE PORTATA IDRAULICA 1/4"	FLOW REGULATOR 1/4"	5	50	XDA.010.0AG	DADO AUTOBLOCCANTE M10	SELF LOCKING NUT M10	2
9	X20.879.200	LAMIERA COLLEGAMENTO BRACCI	UNION LEG LAMIN	18	51	XDA.012.0AG	DADO AUTOBLOCCANTE M12	SELF LOCKING NUT M12	26
10	X20.884.101	SUPPORTO PALO SCORREVOLE	SLIDING POLE SUPPORT	2	52	XDA.024.0AG	DADO AUTOBLOCCANTE M24	SELF LOCKING M24	2
11	X20.910.300	PERNO ROTAZIONE BRACCI	ARM PIN ROTATION	2	53	XDO.24.5589G	DADO BASSO M24	LOWER NUT M24	8
12	X20.937.001	PIASTRA FISSAGGIO SUPPORTO BRACCI	BRACKET	4	54	XID.006.001	INGRASSATORE DIRITTO M6	GREASER	6
13	X20.939.001	SUPPORTO TUBI ROTAZIONE BRACCI	KEEPING ARMS PIPES	2	55	XRP.008.000	RONDELLA PIANA D.8 6592 ZINC.	8 D. FLAT WASHER	10
14	X20.939.101	SUPPORTO TUBI ROTAZIONE BRACCI CON DISCO	KEEPING ARMS PIPES WITH DISK	2	56	XRP.010.000	RONDELLA PIANA D.10 6592 ZINC.	WASHER Ø 10	44
15	X20.940.000	LAMIERA FISSAGGIO TELAIETTO SOSTEGNO BRACCI	BRACKET	6	57	XRP.010.030	RONDELLA PIANA F.LARGA D.10X30 ZINC.	10X30mm D. LARGE THREAD FLAT	8
16	X20.943.100C	APPOGGIO BRACCI A RIPOSO COMPLETO	COMPLETE ARM BLOCK	2	58	XRP.012.000	RONDELLA PIANA Ø12	WASHER Ø12	172
17	X20.948.002.Z	PALO DI DISCESA SNODATO INFERIORE DX ZINCATO	RIGHT LOWER GOING-DOWN PIPE ZINCED	1	59	XRP.012.036	RONDELLA PIANA D12 X 36	WASHER D12 X 36	4
18	X20.948.102.Z	PALO DI DISCESA SNODATO INFERIORE SX ZINCATO	LEFT LOWER GOING-DOWN PIPE ZINCED	1	60	XRP.020.000	RONDELLA PIANA D.20	WASHER D.20	10
19	X20.958.201	TUBO ROTAZIONE BRACCI DX	RIGHT ARMS ROTATION PIPE	1	61	XRP.024.000	RONDELLA PIANA D.24	WASHER D.24	2
20	X20.959.201	TUBO ROTAZIONE BRACCI SX	LEFT ARM ROTATION PIPE	1	62	XRP.024.000	RONDELLA PIANA D.24	WASHER D.24	4
21	X20.969.100	COLLEGAMENTO SCORREVOLE PER BRACCI	SLIDING UNION FOR ARMS	4	63	XS0.480.000	MOLLA PER SERRANDA	SPRING	2
22	X21.019.300	TELAIO FISSO	CENTRAL FRAME	1	64	XS0.493.000	CAVALLOTTO FISSAGGIO CERCHIO PROTEZIONE	SHAPED PLATE FIXING BUMPER	4
23	X21.020.201	BRACCIO SCORREVOLE	SLIDING ARM	4	65	XTE.008.070	VITE TE UNI 5737-65 M8x70-8.8	SCREW TE UNI 5737-65 M8x70-8.8	5
24	X21.022.300	BRACCIO LATERALE DESTRO INFERIORE	RIGHT SIDE ARM	1	66	XTE.010.020T	VITE TE UNI 5739-65 M10x20-8.8	SCREW TE UNI 5739-65 M10x20-8.8	4
25	X21.023.200	BRACCIO LATERALE DESTRO SUPERIORE	HIGH RIGHT ARM	1	67	XTE.010.030T	VITE TE UNI 5739-65 M10x30-8.8	SCREW TE UNI 5739-65 M10x30-8.8	8
26	X21.024.301	TELAIO SCORREVOLE	SLIDING FRAME	1	68	XTE.010.035T	VITE TE UNI 5739-65 M10x35-8.8	SCREW TE UNI 5739-65 M10x35-8.8	16
27	X21.025.300	BRACCIO LATERALE SINISTRO INFERIORE	LEFT SIDE ARM	1	69	XTE.010.040T	VITE TE UNI 5739-65 M10x40-8.8	SCREW TE UNI 5739-65 M10x40-8.8	6
28	X21.026.200	BRACCIO LATERALE SINISTRO SUPERIORE	HIGH LEFT ARM	1	70	XTE.012.030T	VITE TE UNI 5739-65 M12x30-8.8	SCREW TE UNI 5739-65 M12x30-8.8	28
29	X21.027.000	PALO DI DISCESA SNODATO SUPERIORE DX	RIGHT HIGHER GOING-DOWN PIPE	1	71	XTE.012.035T	VITE TE UNI 5739-65 M12X35-8.8	SCREW TE UNI 5739-65 M12X35-8.8	2
30	X21.027.100	PALO DI DISCESA SNODATO SUPERIORE SX	LEFT HIGHER GOING-DOWN PIPE	1	72	XTE.012.080	VITE TE M12X80 5737 ZINC.	BOLT TE M12X80 5737	2
31	X21.115.000	MARTINETTO COMPLETO CORSA L=640	COMPLETE JACK	1	73	XTE.012.090	VITE TE UNI 5737-65 M12x90-8.8	SCREW TE UNI 5737-65 M12x90-8.8	26
32	X50.040.025	ANELLO DI GUIDA IN ACCIAIO INOX	STAINLESS STEEL GUIDE RING	4	74	XTE.012.100	VITE TE UNI 5737-65 M12x100-8.8	SCREW TE UNI 5737-65 M12x100-8.8	24
33	X50.209.000	BRACCIO DI DISCESA SOSTEGNO TESTATA SX	LEFT GOING DOWN ARM	1	75	XTE.012.110	VITE TE UNI 5737-65 M12x110-8.8	SCREW TE UNI 5737-65 M12x110-8.8	16
34	X50.209.100	BRACCIO DI DISCESA SOSTEGNO TESTATA DX	RIGHT GOING DOWN ARM	1	76	XTE.020.080	VITE TE UNI 5737-65 M20x80-8.8	SCREW TE UNI 5737-65 M20x80-8.8	3
35	X50.209.200	BRACCIO DI DISCESA SOSTEGNO TESTATA	GOING-DOWN ARM	2	77	XTE.020.100	VITE TE UNI 5737-65 M20x100-8.8	SCREW TE UNI 5737-65 M20x100-8.8	7
36	X50.211.000	STAFFA ATTACCO DISTRIBUTORE	BRACKET	2	78	XTE.024.100	VITE TE UNI 5737-65 M24x100-8.8	SCREW TE UNI 5737-65 M24x100-8.8	4
37	X50.211.002	PIATTO FISSAGGIO STAFFA ANCORAGGIO	BRACKET	2					
38	X50.226.101	ARCO DI ANCORAGGIO	TIE-ROD	1					
39	X50.227.000	TAMPONE SCORREVOLE	SLIDING BUFFER	2					
40	X50.228.000	TIRANTE DI ANCORAGGIO SINISTRO	LEFT TIE-ROD	1					
41	X50.228.100	TIRANTE DI ANCORAGGIO DESTRO	RIGHT TIE-ROD	1					
42	X50.230.001.Z	CAVALLETTO DI SOSTEGNO BRACCI A RIPOSO ZINCATO	ARM SUPPORT ZINCED	1					

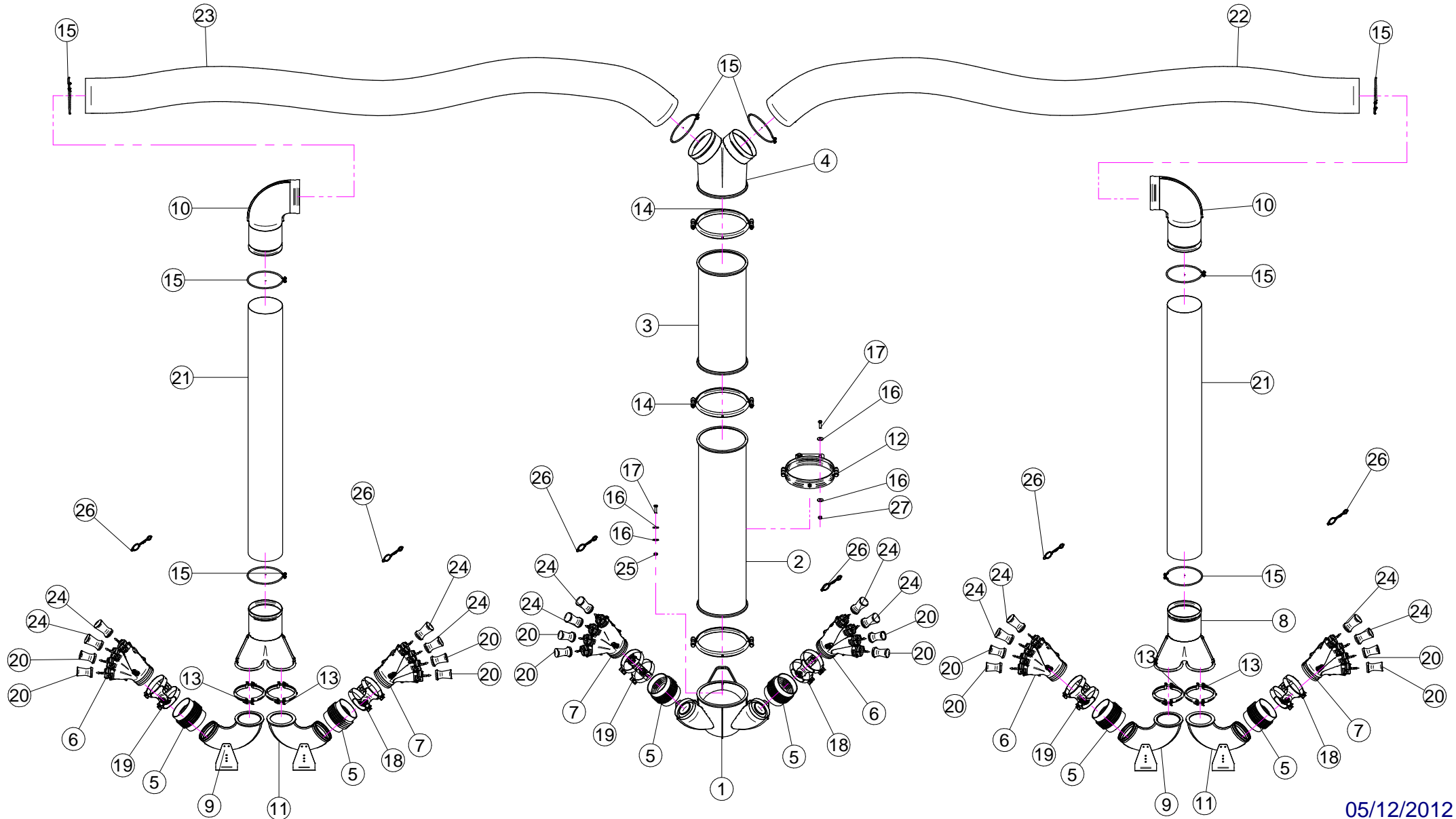



N°	Doc. Number	Titolo	Title	Q.tà	Note
1	X05.843.100	CORPO D.250 CON DUE USCITE D.120 SENZA PRESE D'ARIA CON RIDUZIONI	BODY D.250 WITH 2 OUTLETS D.120	1	
2	X50.075.000	PROLUNGA D.250 x 1000	EXTENSION D.250 x 1000	1	
3	X21.100.060	PROLUNGA D.250 x 600	EXTENSION D.250 x 600	1	
4	X20.649.000	CORPO D.250 CON 2 USCITE D.175	BODY D.250 WITH 2 OUTLETS D.175	1	
5	X02.021.000	MANICOTTO FLESSIBILE D.120	FLEXIBLE SLEEVE	6	
6	X20.014.000DX	MANO A 4 USCITE CON TUBETTI	FOUR OUTLETS	3	
7	X20.014.000SX	MANO A 4 USCITE CON TUBETTI	FOUR OUTLETS	3	
8	X50.210.000	CORPO D.175 CON 2 USCITE D.120	BODY D.175 WITH 2 OUTLETS D.120	2	
9	X04.845.400	CURVA A 130° D.120	ELBOW 130° D.120	2	
10	X20.650.100	CURVA D.175 90° CON 2 PORTAGOMMA D.180	ELBOW D.175 90° WITH 2 RUBBER HOLDER D.180	2	
11	X04.845.300	CURVA A 135° D.120	ELBOW 135° D.120	2	
12	X20.504.000	FASCETTA D.250 FISSAGGIO TESTATE	D.250 CLAMP HEADS FIXING	1	
13	X04.027.000	COLLARE PER TUBI D. 150	PIPE CLAMP D. 150	4	
14	X05.813.000	COLLARE D.275	CLAMP D.275	3	
15	XF0.180.000	FASCETTA UNIFILO D.180	CLAMP D.180	8	
16	XRP.010.030	RONDELLA PIANA D.10 x 30 mm	WASHER D.10 x 30 mm	6	
17	XTE.010.035T	VITE TE 10 x 35	SCREW TE 10 x 35	3	
18	X21.080.000	COPPIA FASCETTE Ø 127 DESTRA	RIGHT CLAMP Ø 127	3	
19	X21.081.000	COPPIA FASCETTE Ø 127 SINISTRA	LEFT CLAMP Ø 127	3	
20	X00.006.050	DIFFUSORE 6/50	NOZZLE 6/50	12	
21	X02.388.150	TUBO SPIRALATO D.180 L=1500	HOSE D.180 L=1500	2	
22	X02.388.500	TUBO POLIURETANO SPIRALATO D.180 L=5000	POLYURETHAN HOSE D.180 L=5000	1	
23	X02.388.500	TUBO POLIURETANO SPIRALATO D.180 L=5000	POLYURETHAN HOSE D.180 L=5000	1	
24	X00.008.050	DIFFUSORE 8/50	NOZZLE 8/50	12	
25	XD0.10.5587G	DADO M10	NUT M10	1	
26	X20.697.000	FERMA DIFFUSORE	NOZZLE STOP	24	
27	XD0.10.5587G	DADO M10	NUT M10	2	

**X20.014.000**

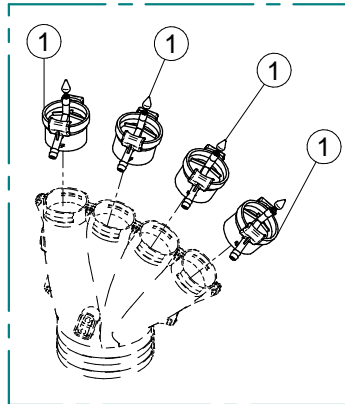

**X20.014.000**

N°	Doc.Number	Titolo	Title	Q.tà
1	X20.016.01C	RACCORDO ATTACCO RAPIDO PORTA TUBETTO	PIPE WITH OLIVE	4

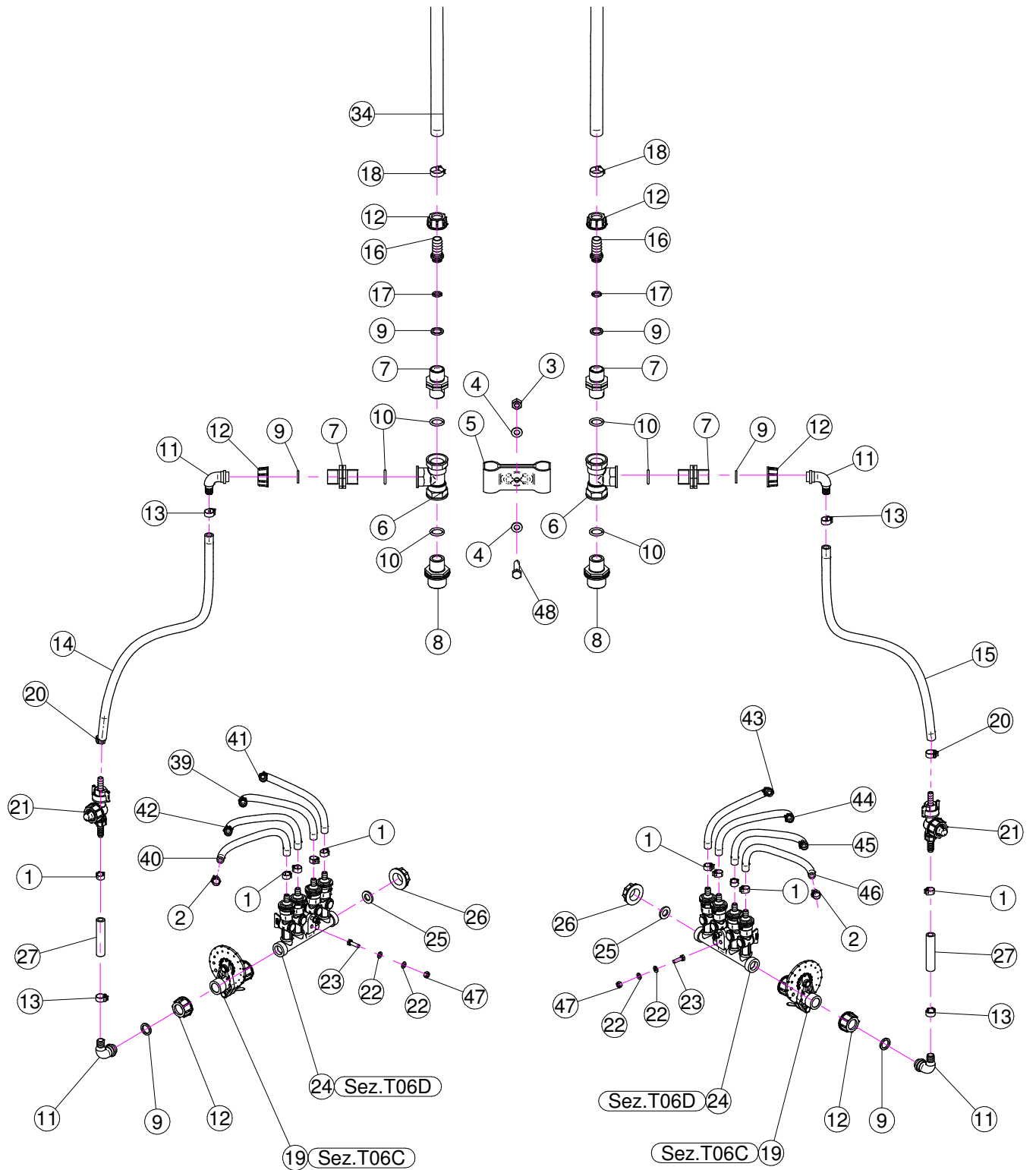

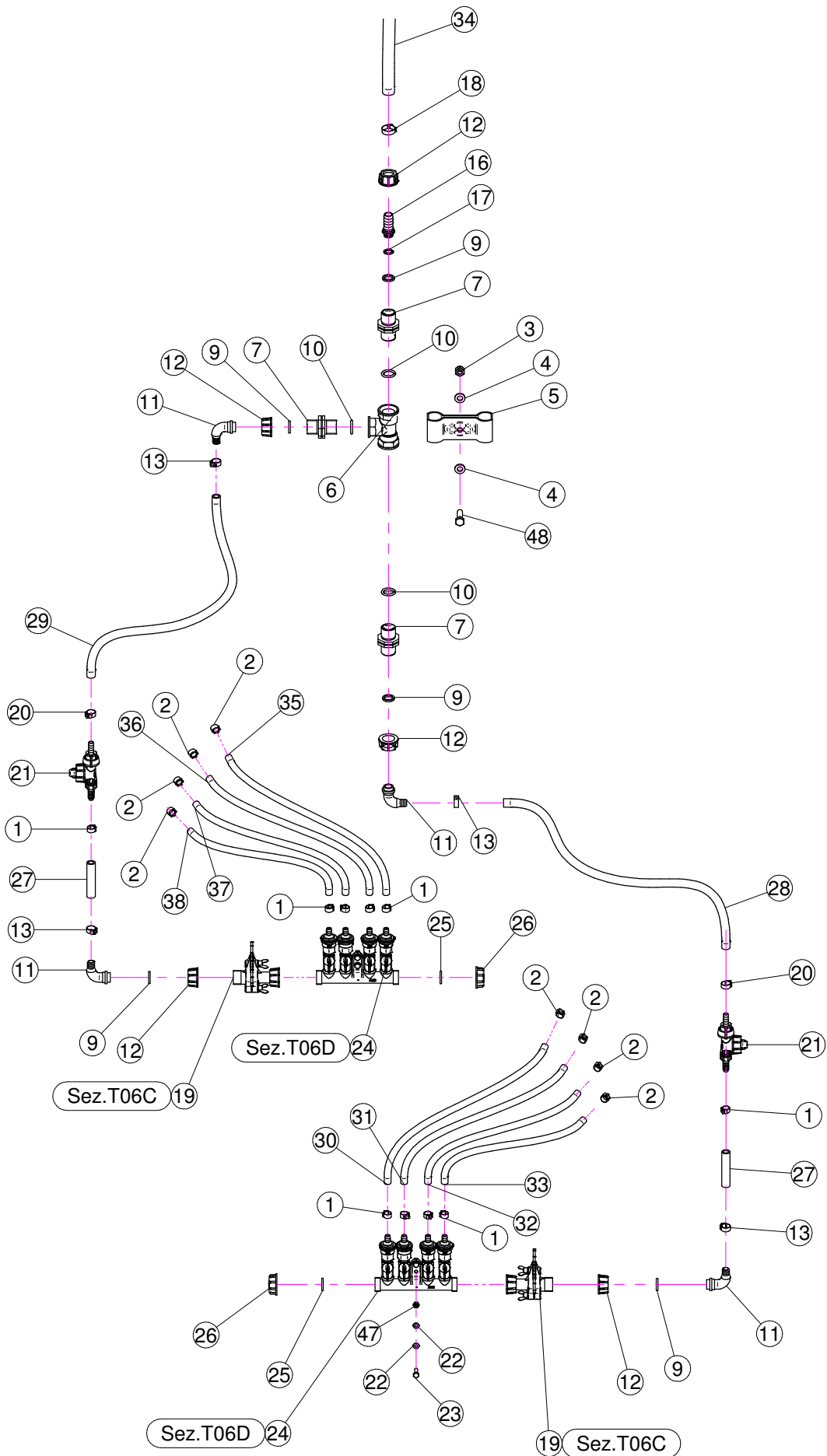

N°	Doc. Number	Titolo	Title	Q.tà	Note
1	XFC.013,5.015	FASCETTA COBRA SLO30710	KOBRA CLAMP	30	
2	XFC.012,5.014	FASCETTA COBRA SLO30705	KOBRA CLAMP	24	
3	XDA.010.0BG	DADO AUTOBLOCCANTE M10	SELF LOCKING NUT M10	3	
4	XRP.010.000	RONDELLA PIANA D.10	WASHER D.10	6	
5	X02.999.000	STAFFA FISSAGGIO RACCORDO A T	T UNION FIXING BRACKET	3	
6	X02.396.000	RACCORDO A T 3/4" - 3/4" - 3/4" F.	UNION 3/4" - 3/4" - 3/4" F.	4	
7	X02.380.000	NIPPLO 3/4"	NIPPLE 3/4"	10	
8	X02.293.000	RIDUZIONE 1" M - 3/4" M	1" M - 3/4" M REDUCER NIPPLE	2	
9	X02.349.000	GUARNIZIONE PIANA D.17X23X3	17X23X3 FLAT GASKET	16	
10	XOR.004.081	OR D.20,22 x 3,53	20,22 x 3,53 O-RING GASKET	12	
11	X00.055.046R	RACCORDO CURVO P.G. D.14	CURVED UNION WITH R.H. D.14	12	
12	X00.055.045	GIRELLO 3/4" GAS	3/4" FLY NUT	16	
13	XFC.016,5.018	FASCETTA COBRA 16,5 - 18	KOBRA CLAMP 16,5 - 18	12	
14	X02.213.060	TUBO D.10 x 16 L=600	HOSE D.10 x 16 L=600	1	
15	X02.213.060	TUBO D.10 x 16 L=600	HOSE D.10 x 16 L=600	1	
16	X02.002.000	RACCORDO DIRITTO 3/4" P.G.18	STRAIGHT UNION 3/4" R.H.18	4	
17	XOR.000.117	OR D. 13,1x18,34x2,62	13,1x18,34x2;62 O-RING GASKET	4	
18	XFC.022,5.024	FASCETTA COBRA 22,5 - 24	KOBRA CLAMP 22,5 - 24	4	
19	X02.150.000	REGOLATORE A DISCO ROTANTE COMPLETO	ROTATION DISK REGULATION	6	
20	XFC.015,5.017	FASCETTA COBRA SLO30720	KOBRA CLAMP	6	
21	X00.226.05C	GETTO ANTIGOCCIA DIRITTO COMPLETO	COMPLETE ANTIDROP	6	
22	XRP.006.000	RONDELLA PIANA D. 6	WASHER D.6	24	
23	XTE.006.020T	VITE TE M6 x 20	SCREW TE M6 x 20	12	
24	X02.008.304C	DISTRIBUTORE LIQUIDI A 4 RUBINETTI	4 TAPS LIQUID MANIFOLD	6	
25	X02.030.010	GUARNIZIONE TAPPO DISTRIBUTORE	GASKET	6	
26	X02.182.000	TAPPO 3/4" FEMMINA	FEMALE 3/4" CAP	6	
27	X02.213.007	TUBO D.10x16 L=70	HOSE D.10x16 L=70	6	
28	X02.213.090	TUBO D.10 x 16 L=900	HOSE D.10 x 16 L=900	2	
29	X02.213.090	TUBO D.10 x 16 L=900	HOSE D.10 x 16 L=900	2	
30	X02.217.041	TUBO D.8 x 13 L=410	HOSE D.8 x 13 L=410	2	
31	X02.217.038	TUBO D.8 x 13 L=380	HOSE D.8 x 13 L=380	2	
32	X02.217.033	TUBO D.8 x 13 L=330	HOSE D.8 x 13 L=330	2	
33	X02.217.029	TUBO D.8 x 13 L=290	HOSE D.8 x 13 L=290	2	
34	X02.211.600	TUBO D.16 x 23 L=6000	HOSE D.16 x 23 L=6000	2	
35	X02.217.041	TUBO D.8 x 13 L=410	HOSE D.8 x 13 L=410	2	
36	X02.217.038	TUBO D.8 x 13 L=380	HOSE D.8 x 13 L=380	2	
37	X02.217.033	TUBO D.8 x 13 L=330	HOSE D.8 x 13 L=330	2	
38	X02.217.029	TUBO D.8 x 13 L=290	HOSE D.8 x 13 L=290	2	
39	X02.217.039	TUBO D.8x13 L=390	HOSE D.8x13 L=390	1	
40	X02.217.029	TUBO D.8x13 L=290	HOSE D.8x13 L=290	1	
41	X02.217.041	TUBO D.8x13 L=410	HOSE D.8x13 L=410	1	
42	X02.217.033	TUBO D.8x13 L=330	HOSE D.8x13 L=330	1	
43	X02.217.041	TUBO D.8x13 L=410	HOSE D.8x13 L=410	1	
44	X02.217.039	TUBO D.8x13 L=390	HOSE D.8x13 L=390	1	
45	X02.217.033	TUBO D.8x13 L=330	HOSE D.8x13 L=330	1	
46	X02.217.029	TUBO D.8x13 L=290	HOSE D.8x13 L=290	1	
47	XD0.06.5588G	DADO M6	NUT M6	12	
48	XTE.010.035T	VITE TE 10 x 35	SCREW TE 10 x 35	3	

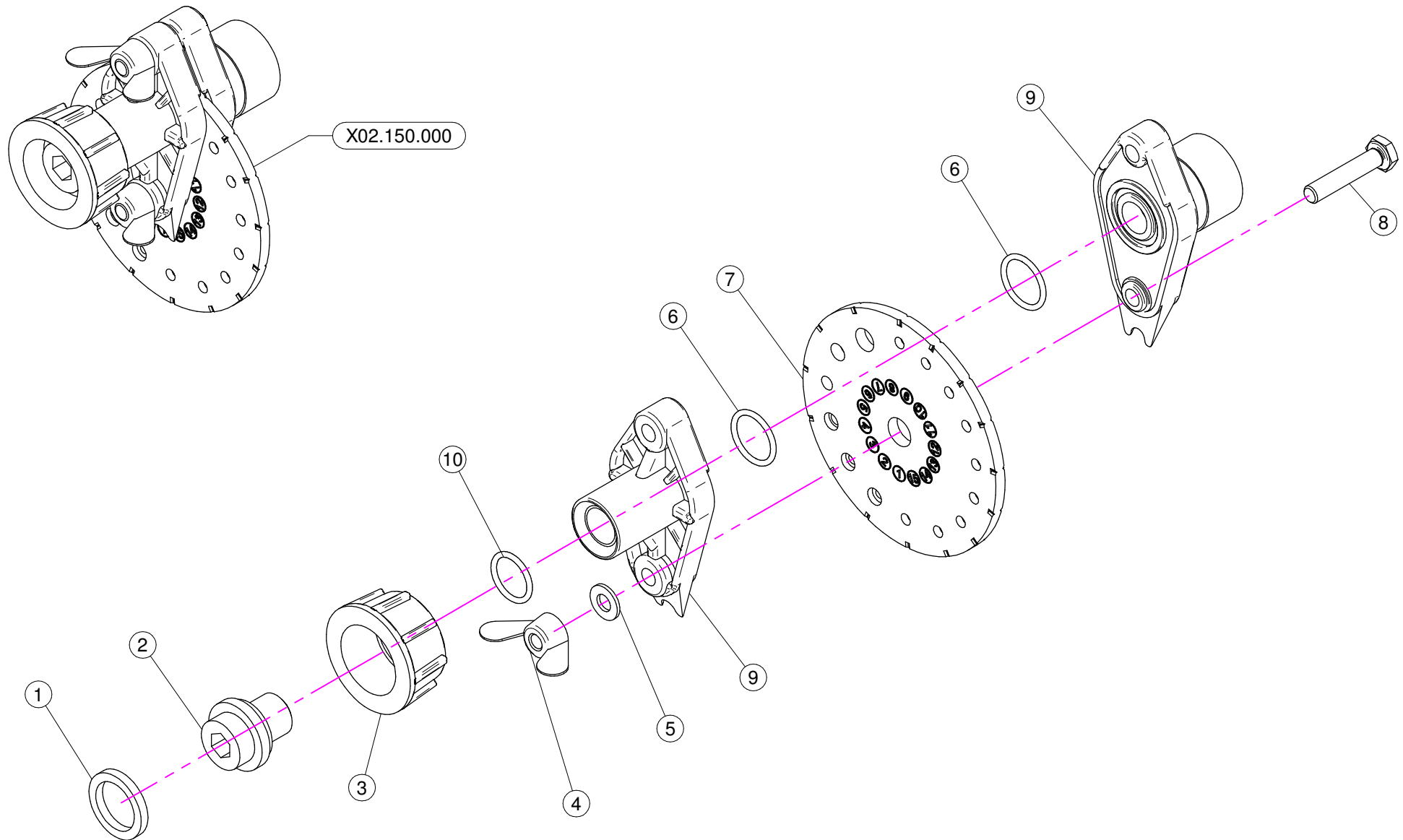

N°	Doc. Number	Titolo	Title	Q.tà	Note
1	X02.349.000	GUARNIZIONE PIANA D.17X23X3	17X23X3 FLAT GASKET	1	
2	X02.117.000	NIPPLO M14X1.5/D.17	ADAPTOR NIPPLE	1	
3	X00.055.045	GIRELLO 3/4" GAS	3/4" FLY NUT	1	
4	XDF.OTT.006	DADO AD ALETTE IN OTTONE M6	WING NUT M6	2	
5	XRP.006.000I	RONDELLA PIANA D. 6 INOX	INOX WASHER D.6	2	
6	XOR.002.062	OR D.15.6X1.78	D.15.6X1.78 OR	2	
7	X02.148.000	DISCO ROTANTE PER REGOLATORE	REGULATOR DISK	1	
8	XTE.006.030I	VITE TE M6X30 INOX	INOX M6X30 BOLT	2	
9	X02.147.500	COPPIA DI SEMICORPO REGOLATORE	REGULATOR HALF-BODY	1	
10	XOR.003.050	OR D.12.37x2.62	O-RING D.12.37x2.62	1	

# X02.008.304C

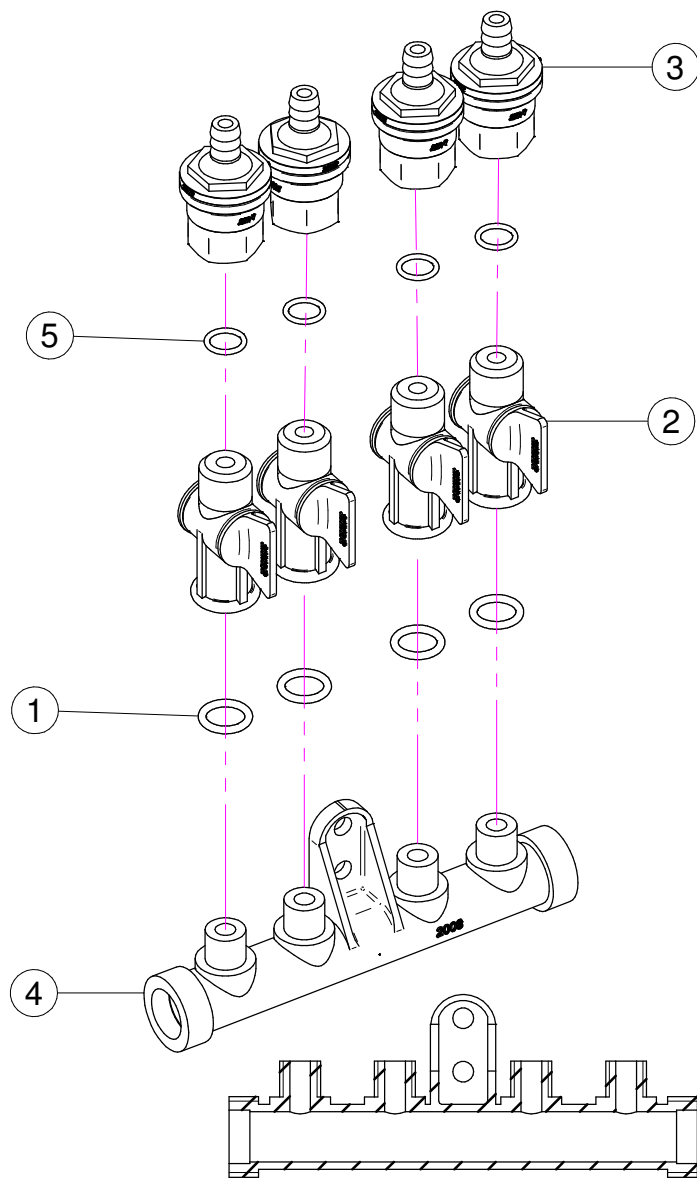

# X02.008.404C

DISTRIBUTORE DIVISO  
DIVIDED MANIFOLD

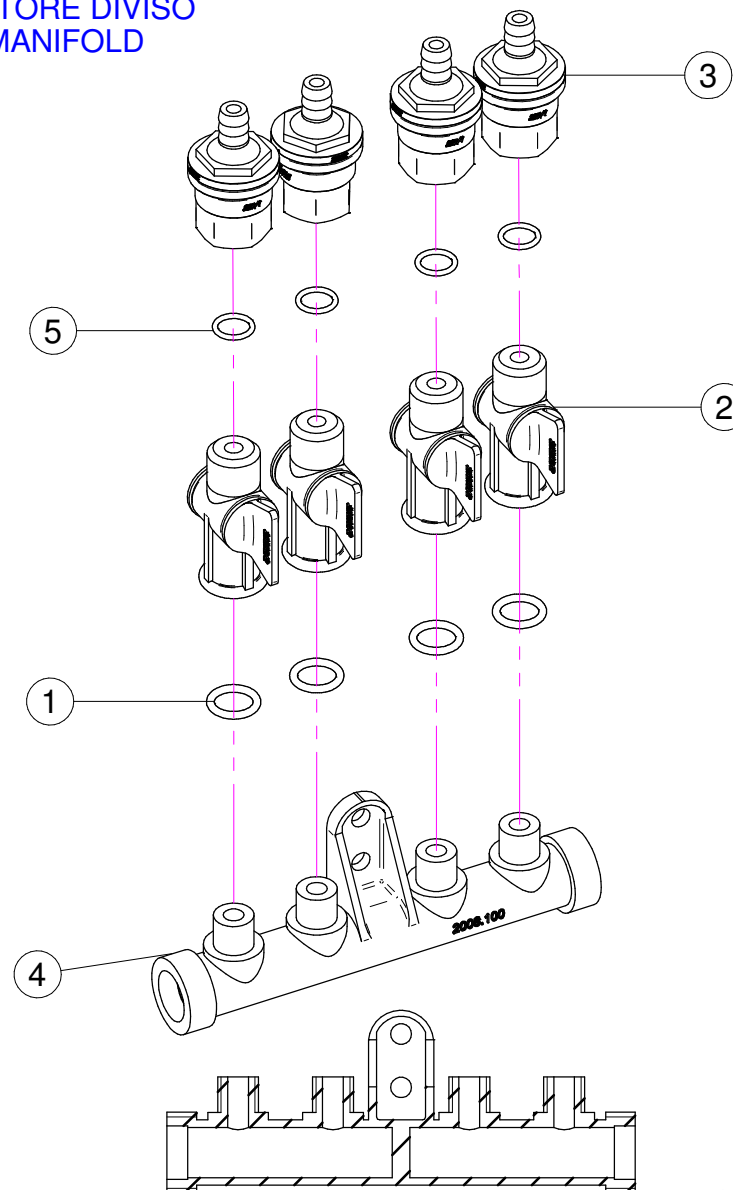

## X02.008.304C

N°	Doc. Number	Titolo	Title	Q.tà	Note
1	XOR.000.117	OR D. 13,1x18,34x2,62	13,1x18,34x2;62 O-RING GASKET	4	
2	X20.202.100	RUBINETTO P.G. D.10 F.1/4" GAS TAGLIATO	TAP ASSEMBLY	4	
3	X00.227.01C	DISPOSITIVO ANTIGOCCIA	ANTDRIP VALVE	4	
4	X02.008.000	DISTRIBUTORE LIQUIDO TESTATE	SPRAYHEADS LIQUID MANIFOLD	1	
5	XOR.002.043	OR 10.82X14.38X1.78 NBR70	10.82X14.38X1.78 NBR70 O-RING GASKET	4	

## X02.008.404C

N°	Doc. Number	Titolo	Title	Q.tà	Note
1	XOR.000.117	OR D. 13,1x18,34x2,62	13,1x18,34x2;62 O-RING GASKET	4	
2	X20.202.100	RUBINETTO P.G. D.10 F.1/4" GAS TAGLIATO	TAP ASSEMBLY	4	
3	X00.227.01C	DISPOSITIVO ANTIGOCCIA	ANTDRIP VALVE	4	
4	X02.008.100	DISTRIBUTORE LIQUIDO TESTATE DIVISO	DIVIDED SPRAYHEADS LIQUID MANIFOLD	1	
5	XOR.002.043	OR 10.82X14.38X1.78 NBR70	10.82X14.38X1.78 NBR70 O-RING GASKET	4	