

N°	Doc. Number	Titolo	Title	Q.tà
1	X02.408.000	RACCORDO DRITTO PER OCCHIO 1/4"	JACK EYE RIGHT UNION 1/4"	2
2	X02.472.000	RONDELLA DI RAME Ø 19x13,5x1,5	COPPER WASHER Ø 19x13,5x1,5	8
3	X02.838.201C(DX)	MARTINETTO COMPLETO CORSA L=156	COMPLETE JACK	1
4	X02.838.201C(SX)	MARTINETTO COMPLETO CORSA L=156	COMPLETE JACK	1
5	X20.227.000	ANELLO GUIDA TUBI PICCOLO	SMALL PIPE GUIDE RING	4
6	X20.685.500.Z	BRACCIO FISSAGGIO DIFFUSORE SINISTRO ZINCATO	LEFT NOZZLE FIXING ARM	1
7	X20.685.600.Z	BRACCIO FISSAGGIO DIFFUSORE DESTRO ZINCATO	RIGHT NOZZLE FIXING ARM	1
8	X20.718.000	REGOLATORE PORTATA IDRAULICA 1/4"	FLOW REGULATOR 1/4"	2
9	X20.870.102	TELAIO SCORREVOLE	SLIDING FRAME	1
10	X20.871.102	BRACCIO LATERALE DESTRO	RIGHT LEG	1
11	X20.872.102	BRACCIO LATERALE SINISTRO	LEFT LEG	1
12	X20.873.100	ANELLO DI SCORRIMENTO DESTRO	RIGHT SLIDING RING	1
13	X20.874.100	ANELLO DI SCORRIMENTO SINISTRO	LEFT SLIDING RING	1
14	X20.900.370	TUBO OLIO PER MARTINETTO L=3700	OIL PIPE FOR JACK L=3700	4
15	X21.044.102	TIRANTE DI SOSTEGNO	TIE-ROD	2
16	X21.049.401	TELAIO CENTRALE FISSO	CENTRAL FRAME	1
17	X21.116.000	PERNO CON ATTACCO TIRANTE	PIN WITH TIE-ROD ATTACH	2
18	XBRF.012.010	BARRA FILETTATA M12 L=100	PIPE M12 L=100	2
19	XD0.10.5587G	DADO M10 6S PG 5587 ZINC.	M10 6S BIG LEAD NUT 5587	8
20	XD0.12.5587G	DADO M12 PG UNI 5587	M12 NUT	4
21	XD0.18.5587G	DADO M18 6S PG 5587 ZINC.	M18 6S BIG LEAD NUT 5587	2
22	XD0.20.5589G	DADO BASSO M20	LOWER NUT M20	4
23	XDA.008.0AG	DADO AUTOBLOCCANTE M8	SELF LOCKING NUT M8	4
24	XID.006.001	INGRASSATORE DIRITTO M6	GREASER	4
25	XRP.008.024	RONDELLA PIANA F.LARGA D.8X24 ZINC.	WASHER D.8X24	4
26	XRP.010.000	RONDELLA PIANA D.10 6592 ZINC.	WASHER Ø 10	4
27	XRP.010.030	RONDELLA PIANA F.LARGA D.10X30 ZINC.	10X30mm D. LARGE THREAD FLAT	12
28	XRP.012.036	RONDELLA PIANA D12 X 36	WASHER D12 X 36	4
29	XRP.018.000	RONDELLA PIANA Ø18	WASHER Ø18	2
30	XRP.020.000	RONDELLA PIANA D.20	WASHER D.20	2
31	XSE.006.028	SPINA ELASTICA 6X28	D.6X28 ELASTYC PIN	2
32	XTE.010.025T	VITE TE M10X25 5739 ZINC.	BOLT TE M10X25 5739	4
33	XTE.010.035T	VITE TE UNI 5739-65 M10x35-8.8	SCREW TE UNI 5739-65 M10x35-8.8	6
34	XTE.010.070T	VITE TE UNI 5739-65 M10x70-8.8	SCREW TE UNI 5739-65 M10x70-8.8	2
35	XTE.012.030T	VITE TE UNI 5739-65 M12x30-8.8	SCREW TE UNI 5739-65 M12x30-8.8	11
36	XTE.020.080	VITE TE UNI 5737-65 M20x80-8.8	SCREW TE UNI 5737-65 M20x80-8.8	2

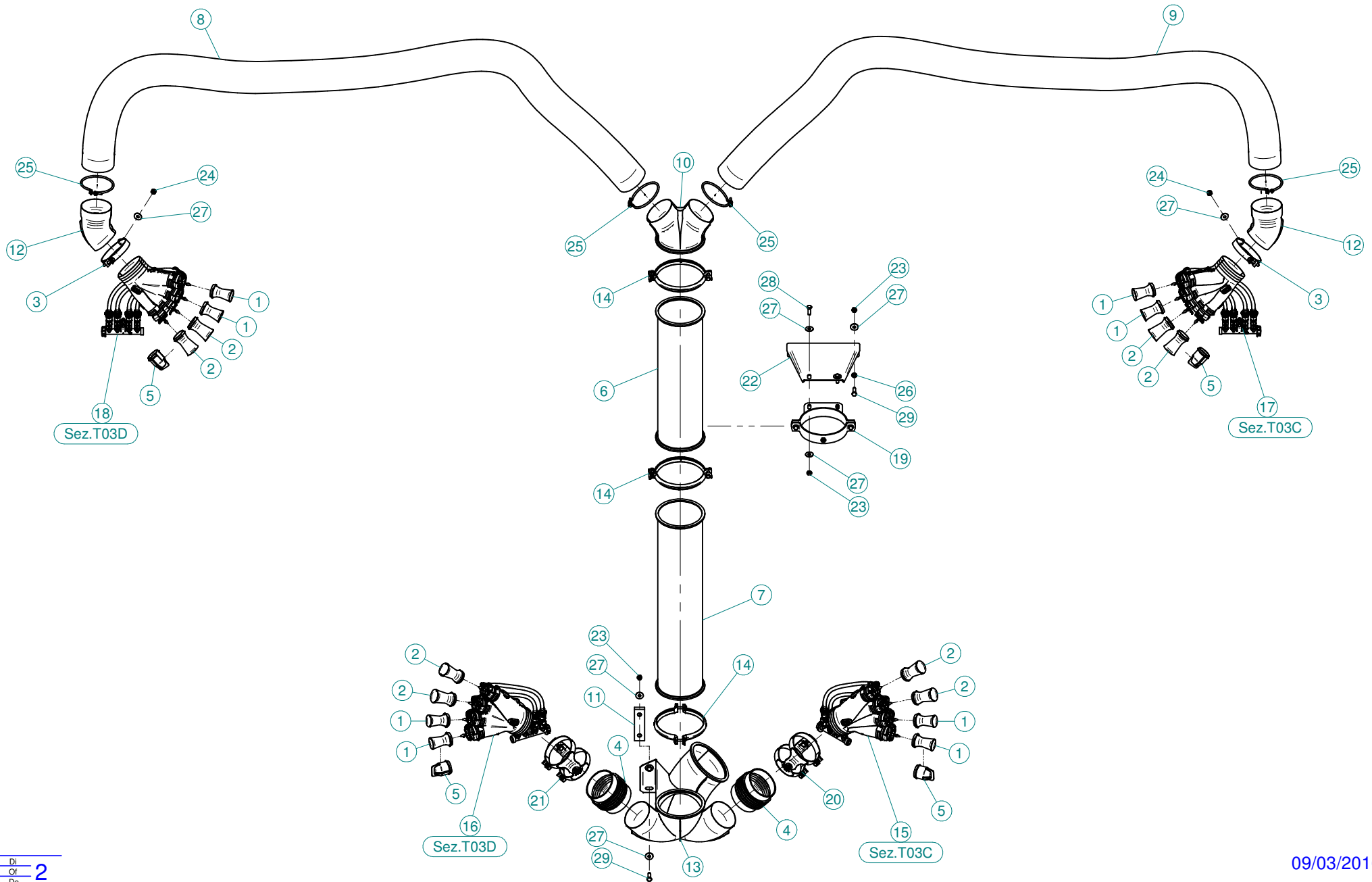

N°	Doc. Number	Titolo	Title	Q.tà
1	X00.006.050	DIFFUSORE 6/50	NOZZLE 6/50	8
2	X00.008.050	DIFFUSORE 8/50	NOZZLE 8/50	8
3	X00.125.001	FEMMINA FASCETTA D.125 ORIENTABILE	FEMALE CLAMP D.125	2
4	X02.021.000	MANICOTTO FLESSIBILE D.120X120	120 D. FLEXIBLE SLEEVE	2
5	X02.127.000	TAPPO DI ATTACCO RAPIDO	CAP NOZZLE PLUG	4
6	X02.188.000	PROLUNGA Ø175 X 600	EXTENSION Ø 175 X 600	1
7	X02.189.000	PROLUNGA Ø175 X 800	EXTENSION Ø175 X 800	1
8	X02.239.300	TUBO SPIRALATO D.120 L=3000	TANEGUM HOSE D.120 L=3000	1
9	X02.239.300	TUBO SPIRALATO D.120 L=3000	TANEGUM HOSE D.120 L=3000	1
10	X02.739.400	CORPO TESTATA D.175 A 2 USCITE	BODY HEAD	1
11	X02.992.000	STAFFA FISSAGGIO CURVE	BRACKET	1
12	X04.845.700	CURVA D.120 A 45°	ELBOW D.120 A 45°	2
13	X04.882.400	CURVA INFERIORE Ø175 PER PORTATI	LOWER BEND Ø175	1
14	X05.616.000	COLLARE PER TUBI Ø 175	PIPE CLAMP Ø 175	3
15	X20.014.404CDX	MANO A 4 USCITE COMPLETA DI DISTRIBUZIONE	FOUR NOZZLES DIFFUSER	1
16	X20.014.404CSX	MANO A 4 USCITE COMPLETA DI DISTRIBUZIONE	FOUR NOZZLES DIFFUSER	1
17	X20.014.504CDX	MANO A 4 USCITE COMPLETA DI DISTRIBUZIONE	FOUR NOZZLES DIFFUSER	1
18	X20.014.504CSX	MANO A 4 USCITE COMPLETA DI DISTRIBUZIONE	FOUR NOZZLES DIFFUSER	1
19	X20.503.000	FASCETTA Ø 175 FISSAGGIO TESTATE	Ø 175 CLAMP HEADS FIXING	1
20	X21.080.000	COPPIA FASCETTE Ø 127 DESTRA	RIGHT CLAMP Ø 127	1
21	X21.081.000	COPPIA FASCETTE Ø 127 SINISTRA	LEFT CLAMP Ø 127	1
22	X40.208.001	STAFFA COMPLETA DI FISSAGGIO	FIXING BRACKET	1
23	XD0.10.5587G	DADO M10 6S PG 5587 ZINC.	M10 6S BIG LEAD NUT 5587	6
24	XDA.010.0BG	DADO AUTOBLOCCANTE M10	SELF LOCKING NUT M10	2
25	XF0.120.000	FASCETTA UNIFILO D.120	CLAMP D.120	4
26	XRP.010.000	RONDELLA PIANA D.10 6592 ZINC.	WASHER Ø 10	2
27	XRP.010.030	RONDELLA PIANA F.LARGA D.10X30 ZINC.	10X30mm D. LARGE THREAD FLAT	12
28	XTE.010.030T	VITE TE UNI 5739-65 M10x30-8.8	SCREW TE UNI 5739-65 M10x30-8.8	2
29	XTE.010.035T	VITE TE UNI 5739-65 M10x35-8.8	SCREW TE UNI 5739-65 M10x35-8.8	4

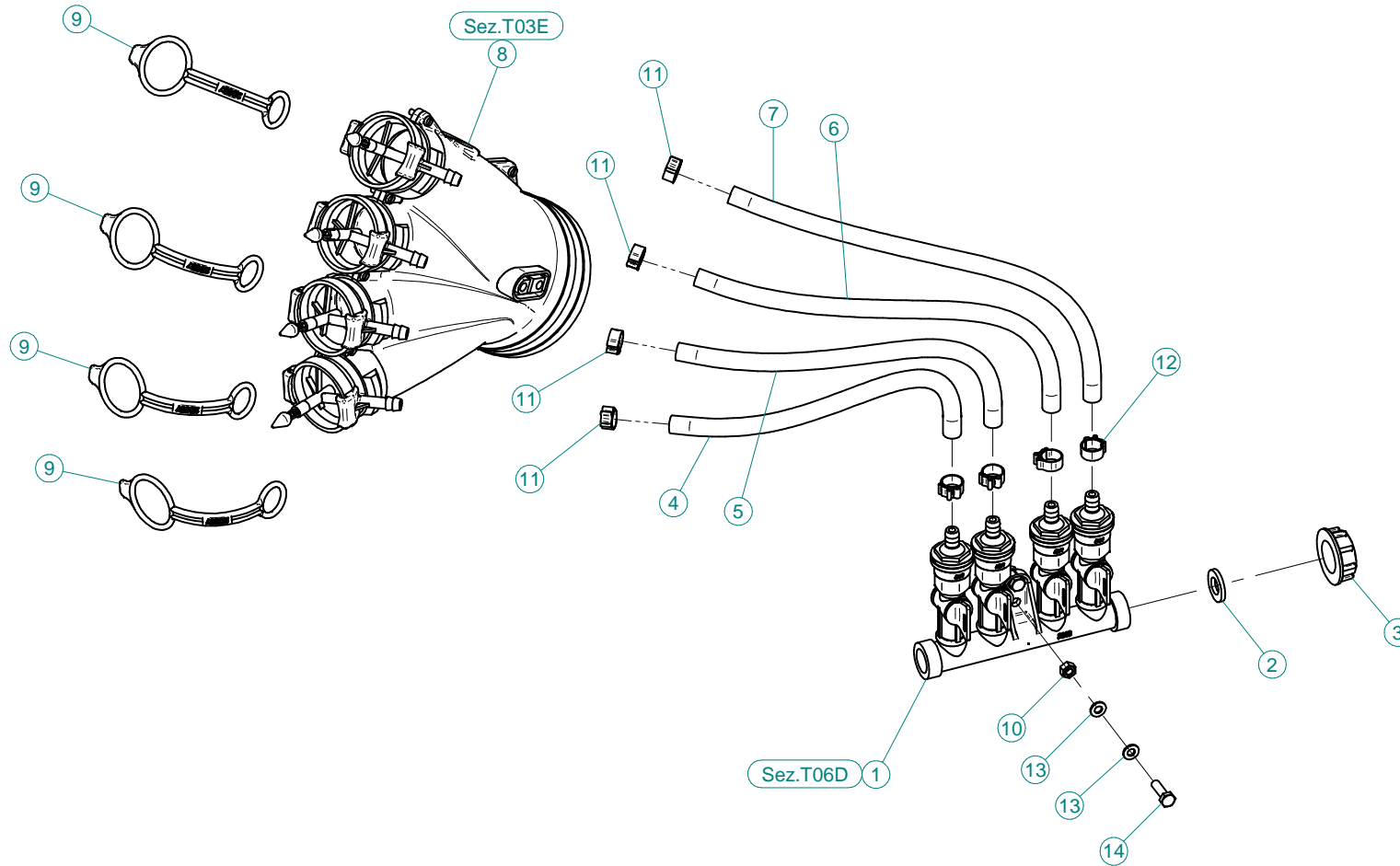

N°	Doc. Number	Titolo	Title	Q.tà
1	X02.008.304C	DISTRIBUTORE LIQUIDI A 4 RUBINETTI CON ANTIGOCCIA	FOUR TAPS LIQUID DISTRIBUTOR WITH ANTI-DRIP DEVICE	1
2	X02.030.010	GUARNIZIONE IN GOMMA D.24X13X3	GASKET D.24X13X3	1
3	X02.182.000	TAPPO 3/4" F.	FEMALE 3/4" CAP	1
4	X02.217.029	TUBO D.8x13 L=290	HOSE D.8x13 L=290	1
5	X02.217.033	TUBO D.8x13 L=330	HOSE D.8x13 L=330	1
6	X02.217.038	TUBO D.8x13 L=380	HOSE D.8x13 L=380	1
7	X02.217.041	TUBO D.8x13 L=410	HOSE D.8x13 L=410	1
8	X20.014.000DX	MANO A 4 USCITE CON TUBETTI	FOUR OUTLETS	1
9	X20.697.000	FERMA DIFFUSORI	NOZZLE STOP	4
10	XD0.06.5588G	DADO M6 6S PG 5588 ZINC.	M6 6S BIG LEAD NUT 5588	2
11	XFC.012,5.014	FASCETTA COBRA SL030705	KOBRA CLAMP SL030705	4
12	XFC.013,5.015	FASCETTA COBRA SL030710	KOBRA CLAMP SL030710	4
13	XRP.006.000	RONDELLA PIANA D.6 6592 ZINC.	6mm D. FLAT WASHER	4
14	XTE.006.020T	VITE TE M6X20 5739 ZINC.	BOLT TE M6X20 5739	2

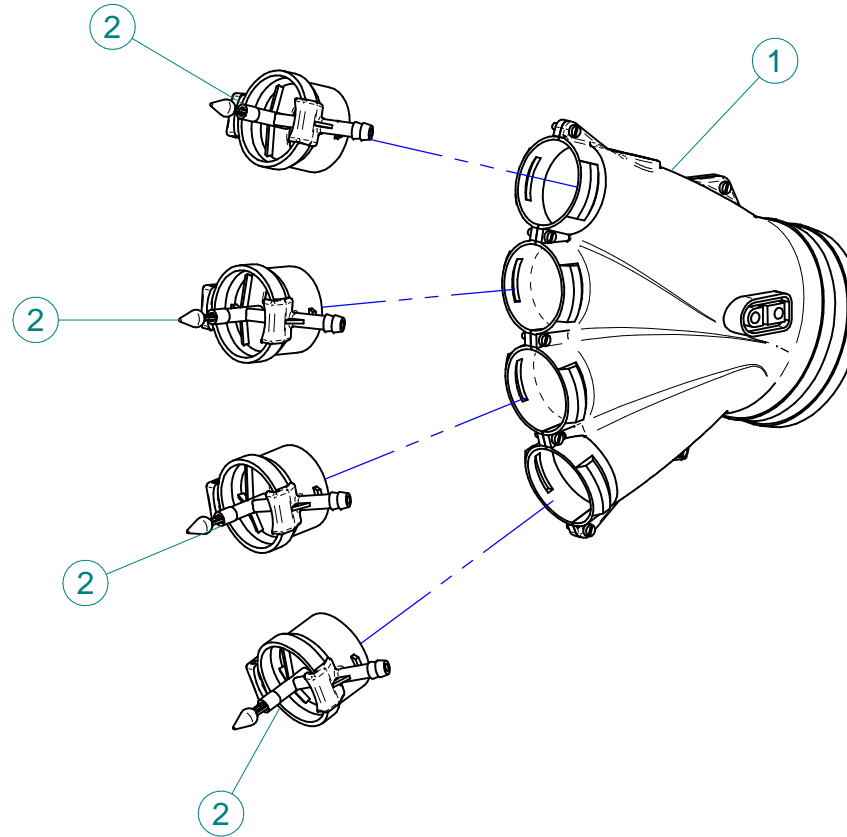

N°	Doc. Number	Titolo	Title	Q.tà
1	X20.014.001DX	MANO A 4 USCITE NUDA	FOUR OUTLETS	1
2	X20.016.01C	RACCORDO ATTACCO RAPIDO PORTA TUBETTO	PIPE WITH OLIVE	4



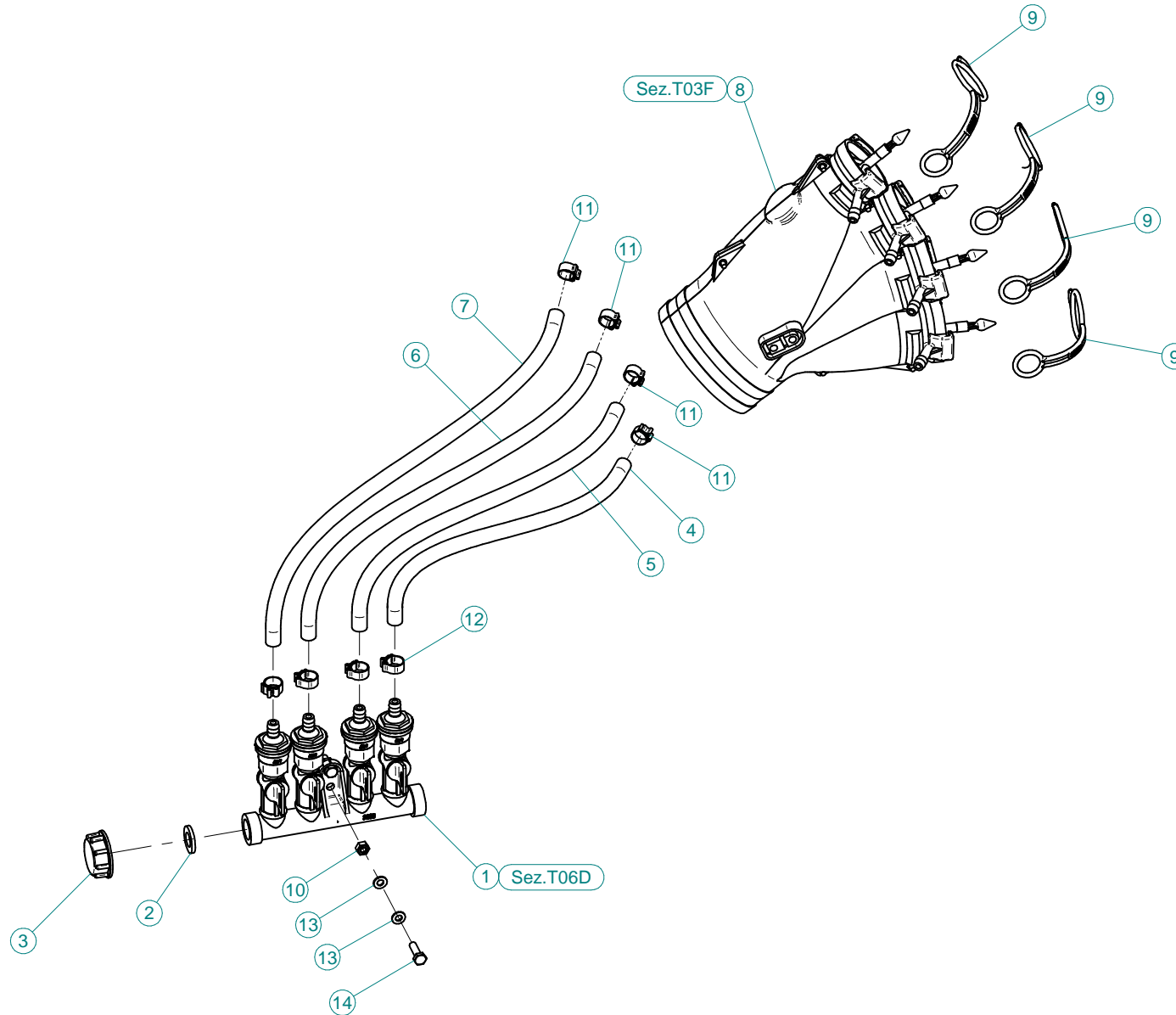

N°	Doc. Number	Titolo	Title	Q.tà
1	X02.008.304C	DISTRIBUTORE LIQUIDI A 4 RUBINETTI CON ANTIGOCCIA	FOUR TAPS LIQUID DISTRIBUTOR WITH ANTI-DRIP DEVICE	1
2	X02.030.010	GUARNIZIONE IN GOMMA D.24X13X3	GASKET D.24X13X3	1
3	X02.182.000	TAPPO 3/4" F.	FEMALE 3/4" CAP	1
4	X02.217.029	TUBO D.8x13 L=290	HOSE D.8x13 L=290	1
5	X02.217.033	TUBO D.8x13 L=330	HOSE D.8x13 L=330	1
6	X02.217.038	TUBO D.8x13 L=380	HOSE D.8x13 L=380	1
7	X02.217.041	TUBO D.8x13 L=410	HOSE D.8x13 L=410	1
8	X20.014.000SX	MANO A 4 USCITE CON TUBETTI	FOUR OUTLETS	1
9	X20.697.000	FERMA DIFFUSORI	NOZZLE STOP	4
10	XD0.06.5588G	DADO M6 6S PG 5588 ZINC.	M6 6S BIG LEAD NUT 5588	2
11	XFC.012,5.014	FASCETTA COBRA SL030705	KOBRA CLAMP SL030705	4
12	XFC.013,5.015	FASCETTA COBRA SL030710	KOBRA CLAMP SL030710	4
13	XRP.006.000	RONDELLA PIANA D.6 6592 ZINC.	6mm D. FLAT WASHER	4
14	XTE.006.020T	VITE TE M6X20 5739 ZINC.	BOLT TE M6X20 5739	2



N°	Doc. Number	Titolo	Title	Q.tà
1	X20.014.001DX	MANO A 4 USCITE NUDA	FOUR OUTLETS	1
2	X20.016.01C	RACCORDO ATTACCO RAPIDO PORTA TUBETTO	PIPE WITH OLIVE	4

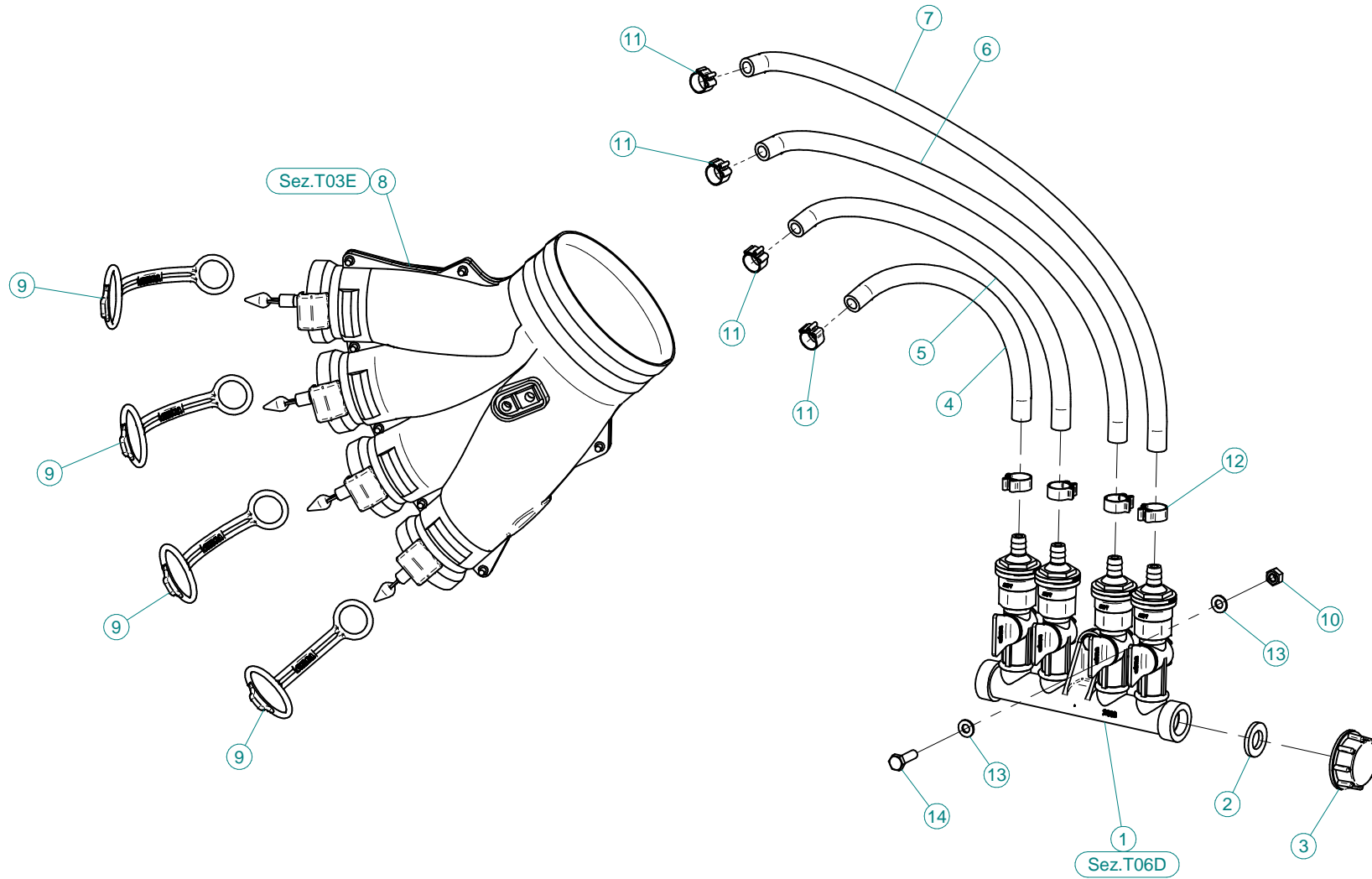

N°	Doc. Number	Titolo	Title	Q.tà
1	X02.008.304C	DISTRIBUTORE LIQUIDI A 4 RUBINETTI CON ANTIGOCCIA	FOUR TAPS LIQUID DISTRIBUTOR WITH ANTI-DRIP DEVICE	1
2	X02.030.010	GUARNIZIONE IN GOMMA D.24X13X3	GASKET D.24X13X3	1
3	X02.182.000	TAPPO 3/4" F.	FEMALE 3/4" CAP	1
4	X02.217.026	TUBO Ø8x13 L=260	HOSE Ø8x13 L=260	1
5	X02.217.034	TUBO Ø8x13 L=340	HOSE Ø8x13 L=340	1
6	X02.217.041	TUBO Ø8x13 L=410	HOSE Ø8x13 L=410	1
7	X02.217.046	TUBO Ø8x13 L=460	HOSE Ø8x13 L=460	1
8	X20.014.000DX	MANO A 4 USCITE CON TUBETTI	FOUR OUTLETS	1
9	X20.697.000	FERMA DIFFUSORI	NOZZLE STOP	4
10	XD0.06.5588G	DADO M6 6S PG 5588 ZINC.	M6 6S BIG LEAD NUT 5588	2
11	XFC.012,5.014	FASCETTA COBRA SL030705	KOBRA CLAMP SL030705	4
12	XFC.013,5.015	FASCETTA COBRA SL030710	KOBRA CLAMP SL030710	4
13	XRP.006.000	RONDELLA PIANA D.6 6592 ZINC.	6mm D. FLAT WASHER	4
14	XTE.006.020T	VITE TE M6X20 5739 ZINC.	BOLT TE M6X20 5739	2

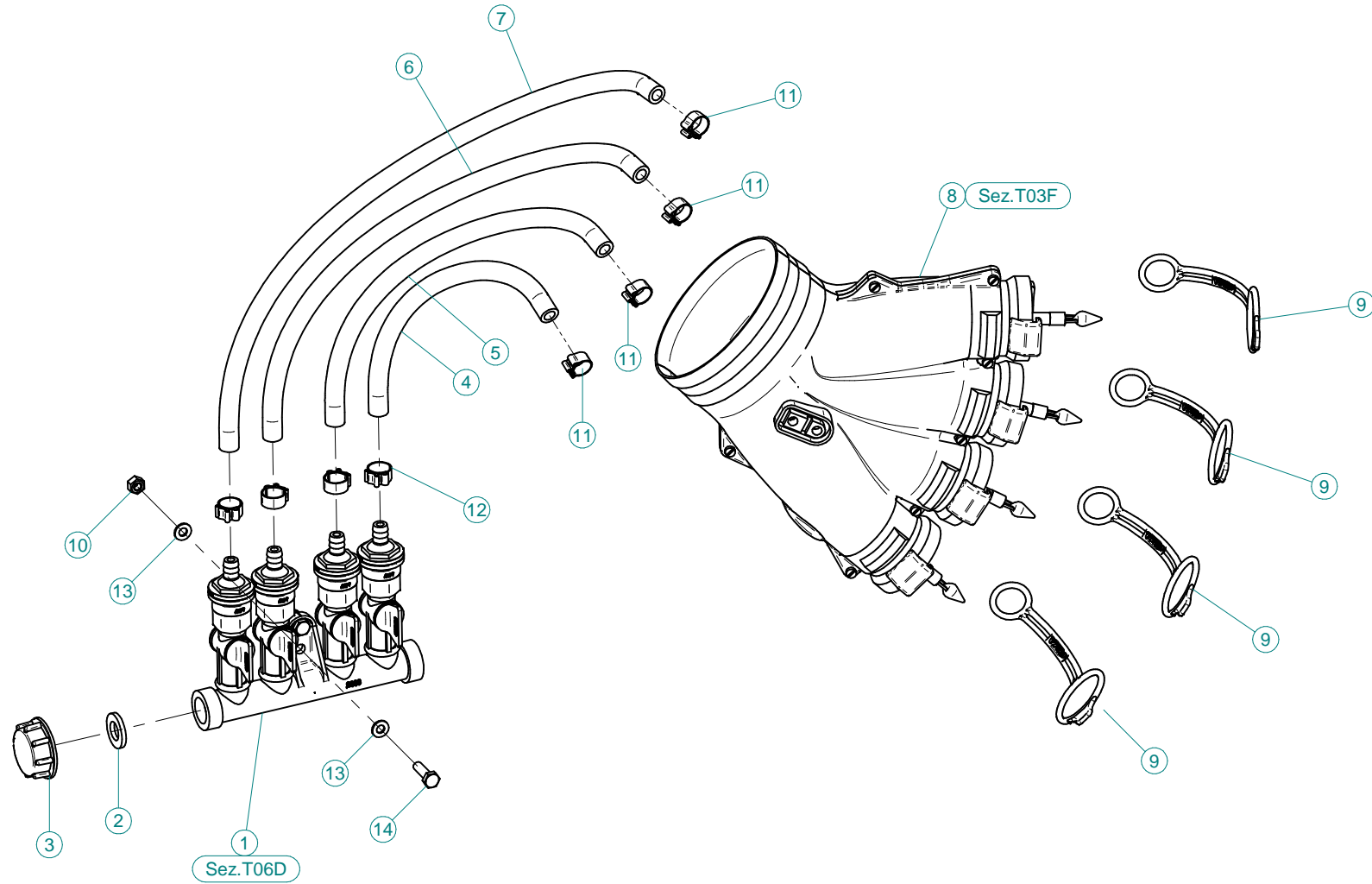

N°	Doc. Number	Titolo	Title	Q.tà
1	X02.008.304C	DISTRIBUTORE LIQUIDI A 4 RUBINETTI CON ANTIGOCCIA	FOUR TAPS LIQUID DISTRIBUTOR WITH ANTI-DRIP DEVICE	1
2	X02.030.010	GUARNIZIONE IN GOMMA D.24X13X3	GASKET D.24X13X3	1
3	X02.182.000	TAPPO 3/4" F.	FEMALE 3/4" CAP	1
4	X02.217.026	TUBO Ø8x13 L=260	HOSE Ø8x13 L=260	1
5	X02.217.034	TUBO Ø8x13 L=340	HOSE Ø8x13 L=340	1
6	X02.217.041	TUBO Ø8x13 L=410	HOSE Ø8x13 L=410	1
7	X02.217.046	TUBO Ø8x13 L=460	HOSE Ø8x13 L=460	1
8	X20.014.000SX	MANO A 4 USCITE CON TUBETTI	FOUR OUTLETS	1
9	X20.697.000	FERMA DIFFUSORI	NOZZLE STOP	4
10	XD0.06.5588G	DADO M6 6S PG 5588 ZINC.	M6 6S BIG LEAD NUT 5588	2
11	XFC.012,5.014	FASCETTA COBRA SL030705	KOBRA CLAMP SL030705	4
12	XFC.013,5.015	FASCETTA COBRA SL030710	KOBRA CLAMP SL030710	4
13	XRP.006.000	RONDELLA PIANA D.6 6592 ZINC.	6mm D. FLAT WASHER	4
14	XTE.006.020T	VITE TE M6X20 5739 ZINC.	BOLT TE M6X20 5739	2

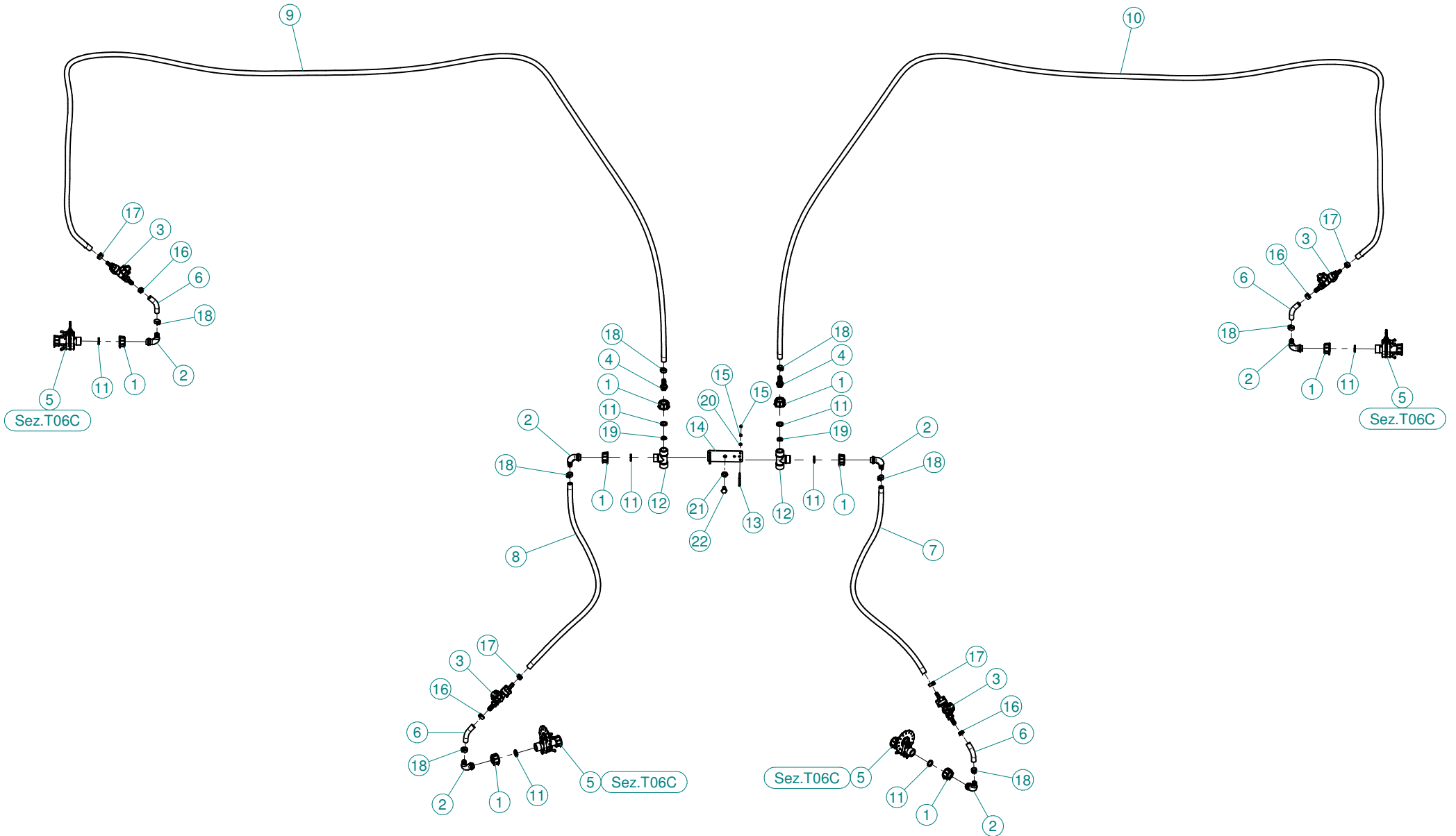



N°	Doc. Number	Titolo	Title	Q.tà
1	X00.055.045	GIRELLO 3/4" GAS ALTO	3/4" GAS FLY NUT	8
2	X00.055.046R	RACCORDO CURVO P.G. Ø 14	CURVED UNION WITH R.H. D.14	6
3	X00.226.05C	GETTO ANTIGOCCIA DIRITTO COMPLETO (0,3 bar)	COMPLETE ANTIDROP (0,3 bar)	4
4	X02.122.000	RACCORDO A P.G. Ø 13	Ø 13 UNION	2
5	X02.150.000	REGOLATORE A DISCO ROTANTE COMPLETO	ROTATION DISK REGULATION	4
6	X02.213.007	TUBO Ø10x16 L=70	HOSE Ø10x16 L=70	4
7	X02.213.100	TUBO Ø10x16 L=1000	HOSE Ø10x16 L=1000	1
8	X02.213.100	TUBO Ø10x16 L=1000	HOSE Ø10x16 L=1000	1
9	X02.213.400	TUBO Ø10x16 L=4000	HOSE Ø10x16 L=4000	1
10	X02.213.400	TUBO Ø10x16 L=4000	HOSE Ø10x16 L=4000	1
11	X02.349.000	GUARNIZIONE PIANA D.17X23X3	17X23X3 FLAT GASKET (G4000B)	8
12	X21.013.000	RACCORDO A "T" 3/4 - 3/4	"T" UNION 3/4 - 3/4	2
13	X21.013.000.A	CAVALLOTTO DI FISSAGGIO RACCORDO A T	BRACKET FOR TEE	2
14	X21.039.000	STAFFETTA PORTA "T"	BRACKET	1
15	XDOT.04.5588	DADO OTTONE M4	M4 BRASS NUT	8
16	XFC.013,5.015	FASCETTA COBRA SL030710	KOBRA CLAMP SL030710	4
17	XFC.015,5.017	FASCETTA COBRA SLO30720	KOBRA CLAMP	4
18	XFC.016,5.018	FASCETTA COBRA 16,5 - 18	KOBRA CLAMP 16,5 - 18	8
19	XOR.000.117	OR D.13,1X2,62	13.1X2.62 O-RING GASKET	2
20	XRP.004.000	RONDELLA PIANA D.4	INOX WASHER D.4	4
21	XRP.010.000	RONDELLA PIANA D.10 6592 ZINC.	WASHER Ø 10	1
22	XTE.010.016T	VITE TE UNI 5739-65 M10x16-8.8	SCREW TE UNI 5739-65 M10x16-8.8	1



N°	Doc. Number	Titolo	Title	Q.tà
1	X02.147.500	COPPIA DI SEMICORPO REGOLATORE	REGULATOR HALF-BODY	1
2	X02.148.000	DISCO ROTANTE PER REGOLATORE	REGULATOR DISK	1
3	X02.349.000	GUARNIZIONE PIANA D.17X23X3	17X23X3 FLAT GASKET (G4000B)	1
4	XDF.OTT.006	DADO AD ALETTE IN OTTONE M6	BRASS M6 WING NUT	2
5	XOR.002.062	OR D.15,6X1,78	15.6X1.78 O-RING GASKET	2
6	XRP.006.00I	RONDELLA PIANA D.6 INOX	WASHER D.6	2
7	XTE.006.030I	VITE TE M6X30 INOX 5739	BOLT TE M6X30 STAINLESS STEEL 5739	2



N°	Doc. Number	Titolo	Title	Q.tà
1	X00.227.01C	DISPOSITIVO ANTIGOCCIA	ANTI DRIP DEVICE	4
2	X02.008.000	DISTRIBUTORE LIQUIDO TESTATE	SPRAYHEADS LIQUID DISTRIBUTOR	1
3	X20.202.100	RUBINETTO F.1/4" M.18X1,5	TAP ASSEMBLY	4
4	XOR.000.117	OR D.13,1X2,62	13.1X2.62 O-RING GASKET	4

Gli esplosi elencati di seguito sono relativi  
a varianti o accessori a richiesta

The exploded drawings listed below are related  
to different versions or optional accessories

Le vues éclatées suivantes sont relatives  
à des variantes ou à des accessoires optionnels

Dibujos de vista despiezada son relativos a  
variantes o accesorios opcionales

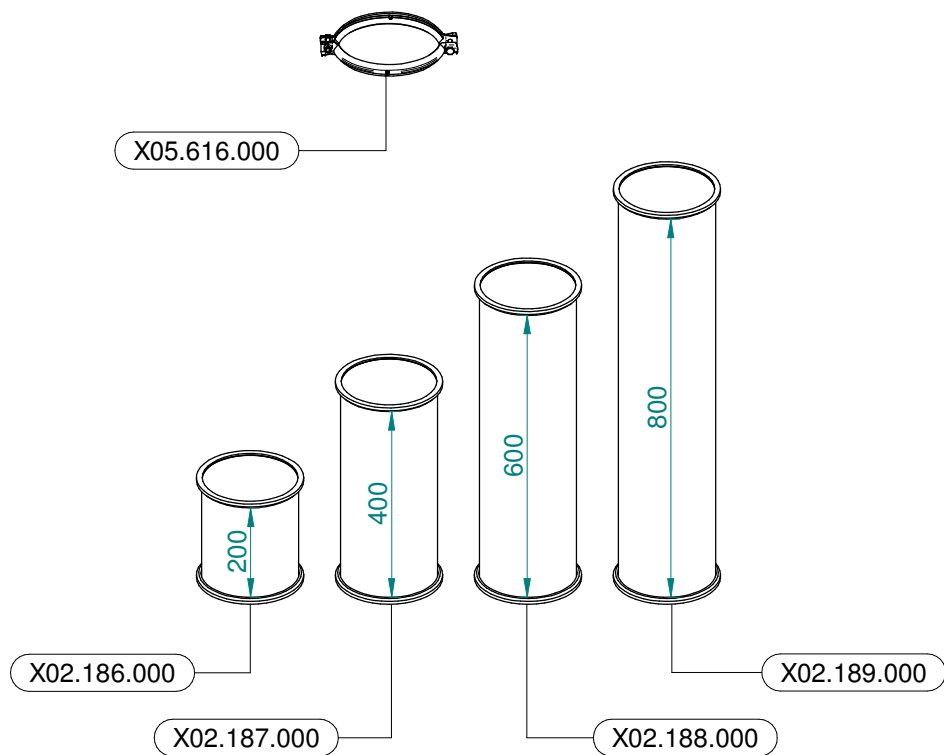

**Ø 175**  
 Plus 42 - 45 - 50  
 Blitz 45 - 50  
 Link 50

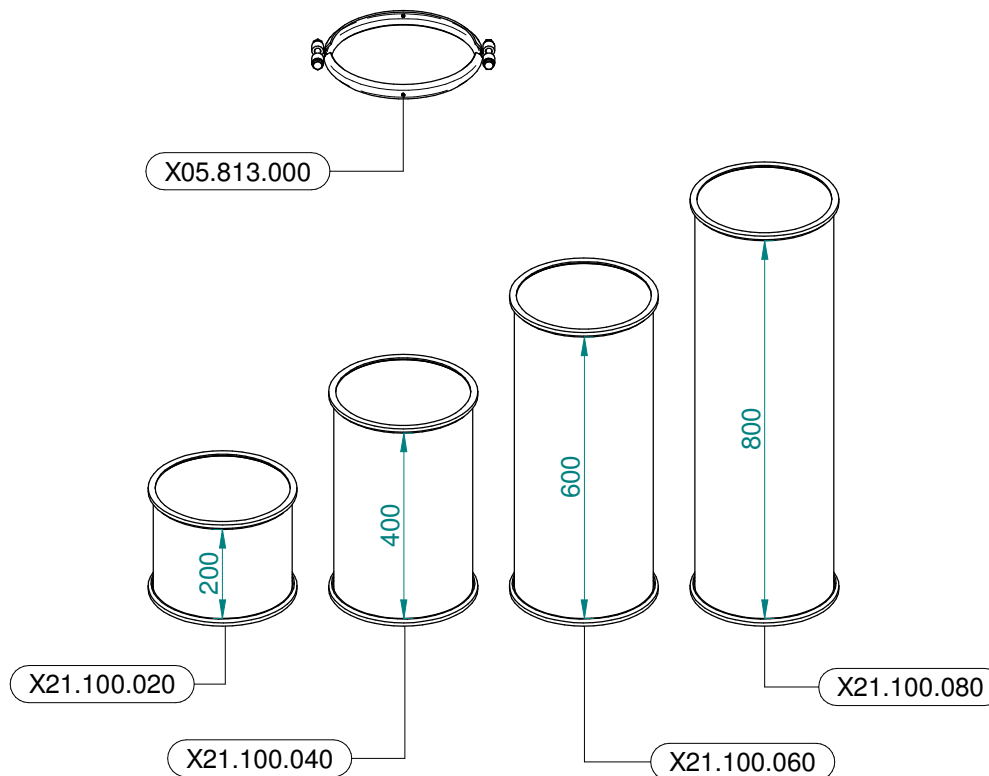

**Ø 250**  
 Plus 55  
 Blitz 55  
 Link 55