

(⌘) A richiesta / Optional Devices

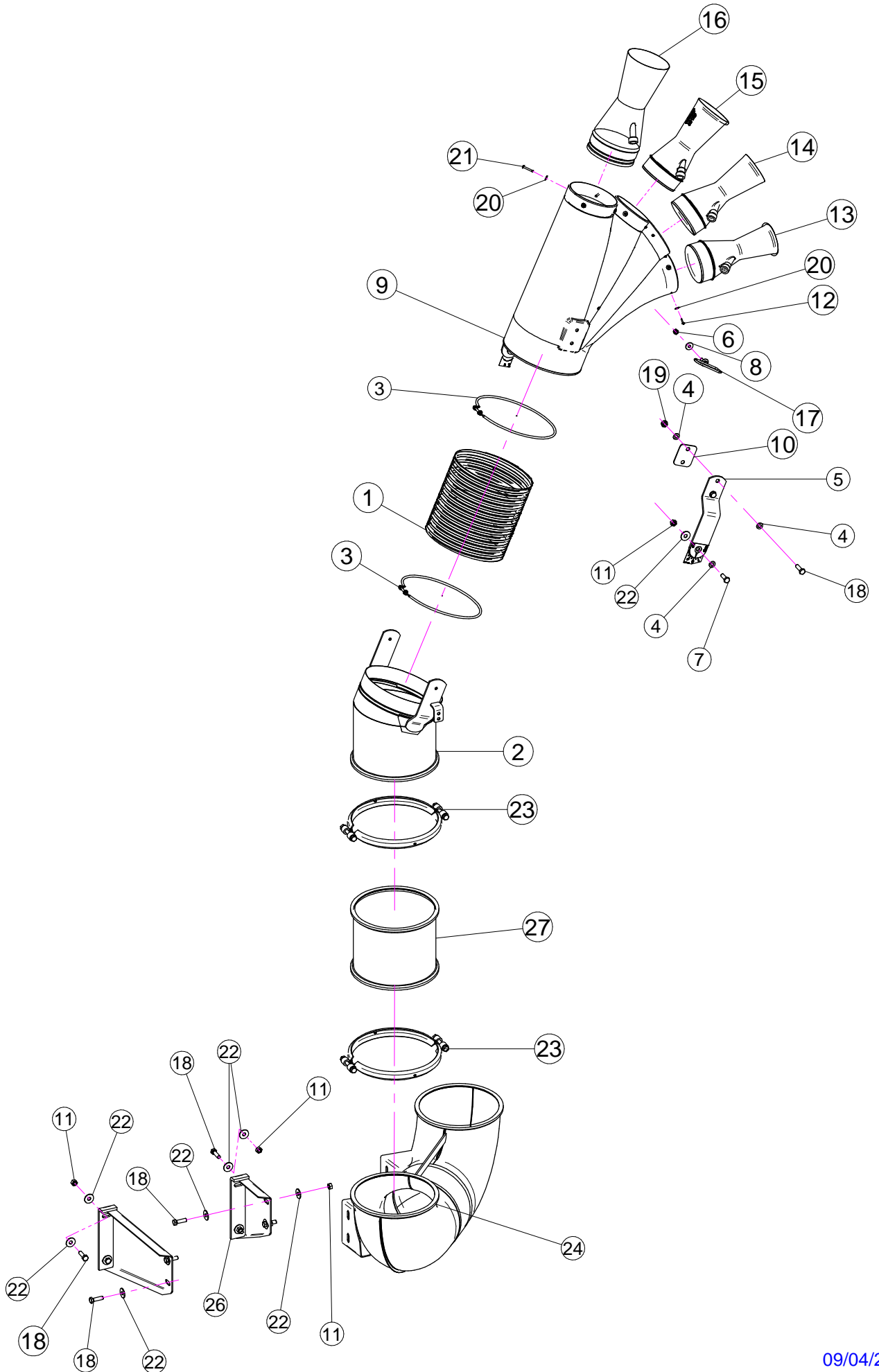

N°	Doc. Number	Titolo	Title	Q.tà	Note
1	X02.314.025	TUBO IN POLIURETANO D.250 L=250	POLIURETAN HOSE D.250 L=250	1	
2	X02.809.010	CORPO INFERIORE GETTO OLIVO D.250	LOWER BODY FOR OLIVE SPRAYHEAD	1	
3	XF0.250.000	FASCETTA UNIFILO D.250	CLAMP D.250	2	
4	XRP.010.000	RONDELLA PIANA D.10	WASHER D.10	10	
5	X00.053.001	Piatto snodo getto olivo	Joint	2	
6	XDA.008.0AG	DADO AUTOBLOCCANTE M8	SELF LOCKING NUT M8	1	
7	XTE.010.030T	VITE TE M10 x 30	SCREW TE M10 x 30	2	
8	XRP.008.024	RONDELLA PIANA LARGA D.8X24	WASHER D.8X24	1	
9	X00.053.000	Corpo getto olivo	Olive body	1	
10	X00.053.002	Piatto di rinforzo	Plate	2	
11	XD0.10.5587G	DADO M10	NUT M10	8	
12	XTA.03,9.016I	VITE AUTOFILETTANTE D. 3,9x16 INOX	SELF-THREADED D. 3,9x16	12	
13	X10.022,5.120	DIFFUSORE 22,5/120 CON TUBETTO	NOZZLE 22,5/120	1	
14	X10.027.120	DIFFUSORE 27/120 CON TUBETTO	NOZZLE 27/120	1	
15	X10.037.120	DIFFUSORE 37/120 CON TUBETTO	NOZZLE 37/120	1	
16	X10.055.150	Diffusore 55/150 con tubetto	Nozzle 55/150	1	
17	X21.036.000	FASCETTA PASSATUBI	BRACKET	1	
18	XTE.010.035T	VITE TE 10 x 35	SCREW TE 10 x 35	12	
19	XDA.010.0BG	DADO AUTOBLOCCANTE M10	SELF LOCKING NUT M10	4	
20	XRP.005.015I	RONDELLA PIANA D. 5x15	WASHER D. 5x15	16	
21	XRV.4,8.030	RIVETTO D.4,8 x 30	RIVET D.4,8 x 30	4	
22	XRP.010.030	RONDELLA PIANA D.10 x 30 mm	WASHER D.10 x 30 mm	16	
23	X05.813.000	COLLARE D.275	CLAMP D.275	2	
24	X05.802.050	CURVA A 180° D. 250	ELBOW 180° D. 250	1	
25*	X05.802.051	STAFFA FISSAGGIO CURVA D.250 A 180°	ELBOW FIXING BRACKET	1	
26	X05.802.151	STAFFA FISSAGGIO CURVA D.250 A 180°	ELBOW FIXING BRACKET	1	
27	X21.100.020	PROLUNGA D.250 x 200	EXTENSION D.250 x 200	1	

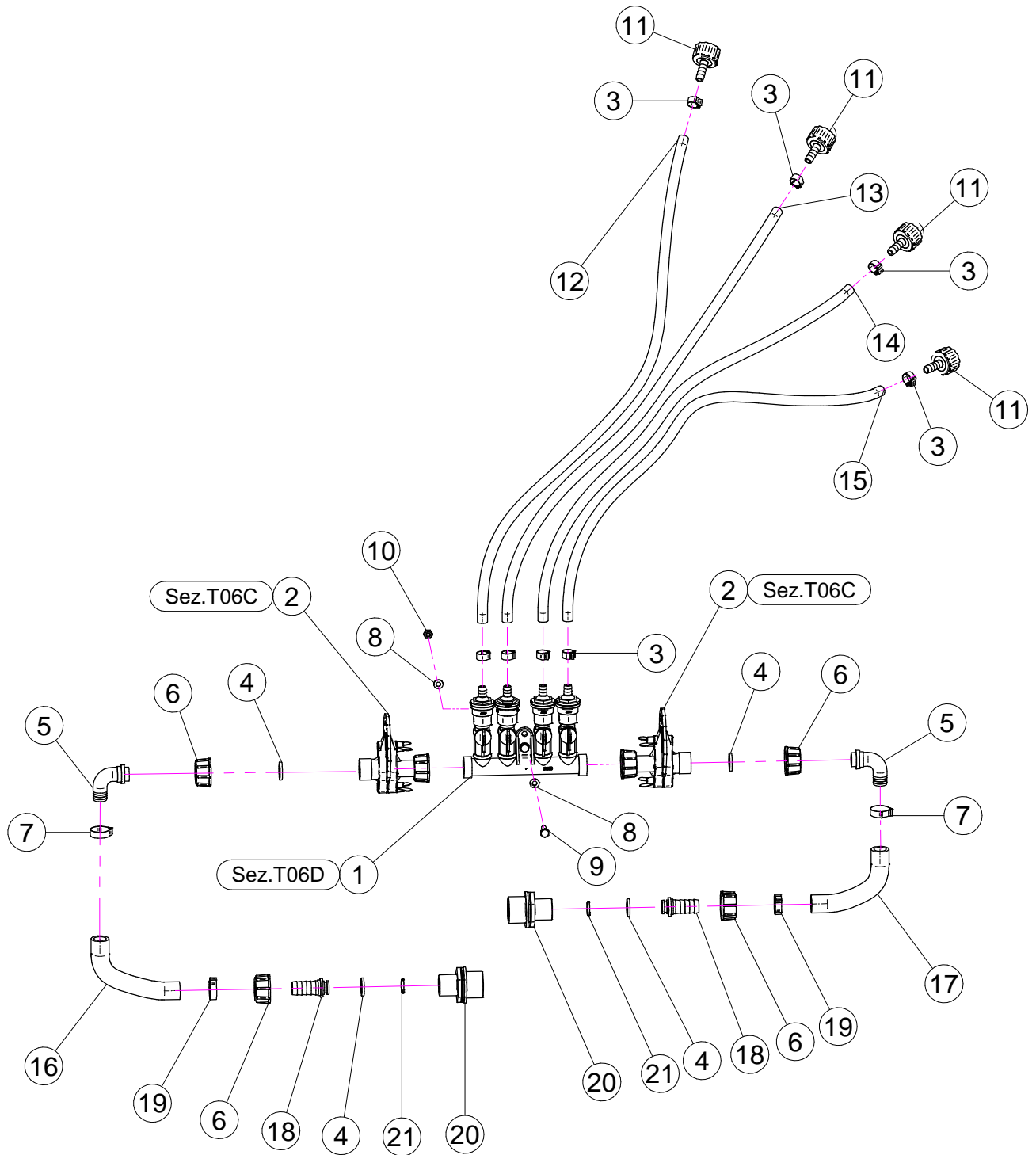

N°	Doc. Number	Titolo	Title	Q.tà	Note
1	X02.008.304C	DISTRIBUTORE LIQUIDI A 4 RUBINETTI	4 TAPS LIQUID MANIFOLD	1	
2	X02.150.000	REGOLATORE A DISCO ROTANTE COMPLETO	ROTATION DISK REGULATION	2	
3	XFC.013,5.015	FASCETTA COBRA SLO30710	KOBRA CLAMP	8	
4	X02.349.000	GUARNIZIONE PIANA D.17X23X3	17X23X3 FLAT GASKET	4	
5	X00.055.046	RACCORDO CURVO P.G. D.17	CURVED UNION WITH R.H. D.17	2	
6	X00.055.045	GIRELLO 3/4" GAS	3/4" FLY NUT	4	
7	XFC.023,5.025	FASCETTA COBRA 23,5 - 25	KOBRA CLAMP 23,5 - 25	2	
8	XRP.006.000	RONDELLA PIANA D. 6	WASHER D.6	4	
9	XTE.006.020T	VITE TE M6 x 20	SCREW TE M6 x 20	2	
10	XD0.06.5588G	DADO M6	NUT M6	2	
11	X21.010.000	RACCORDO P.G. DIRITTO D.10 COMPLETO	COMPLETE R.H. D.10 UNION	4	
12	X02.217.082	TUBO D.8x13 L=820	HOSE D.8x13 L=820	1	
13	X02.217.071	TUBO D.8x13 L=710	HOSE D.8x13 L=710	1	
14	X02.217.066	TUBO D.8x13 L=660	HOSE D.8x13 L=660	1	
15	X02.217.060	TUBO D.8x13 L=600	HOSE D.8x13 L=600	1	
16	X02.211.020	TUBO D.16x23 L=200	HOSE D.16x23 L=200	1	
17	X02.211.020	TUBO D.16x23 L=200	HOSE D.16x23 L=200	1	
18	X02.002.000	RACCORDO DIRITTO 3/4" P.G.18	STRAIGHT UNION 3/4" R.H.18	2	
19	XFC.022,5.024	FASCETTA COBRA 22,5 - 24	KOBRA CLAMP 22,5 - 24	2	
20	X02.293.000	RIDUZIONE 1" M - 3/4" M	1" M - 3/4" M REDUCER NIPPLE	2	
21	XOR.000.117	OR D. 13,1x18,34x2,62	13,1x18,34x2,62 O-RING GASKET	2	

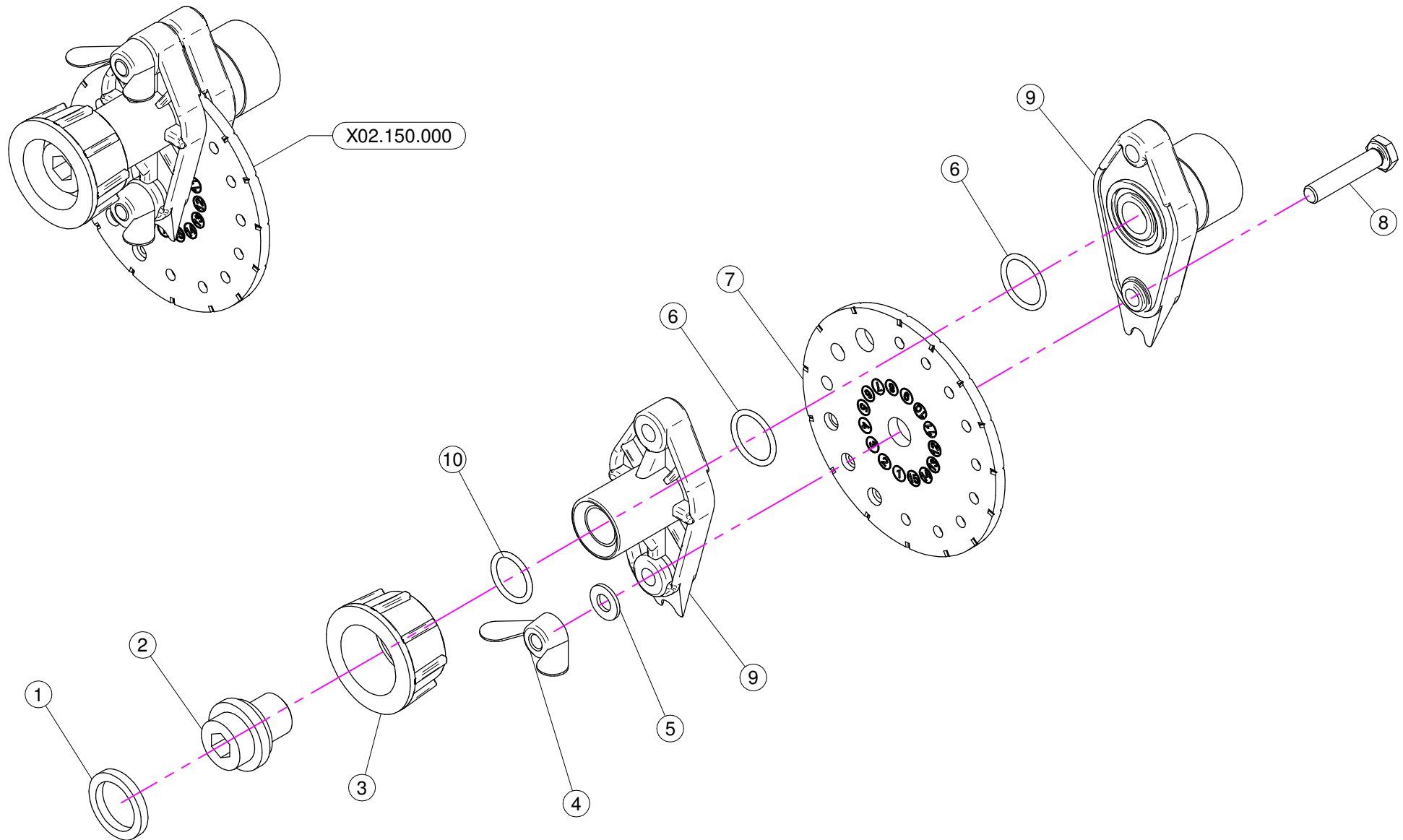

N°	Doc. Number	Titolo	Title	Q.tà	Note
1	X02.349.000	GUARNIZIONE PIANA D.17X23X3	17X23X3 FLAT GASKET	1	
2	X02.117.000	NIPPLO M14X1.5/D.17	ADAPTOR NIPPLE	1	
3	X00.055.045	GIRELLO 3/4" GAS	3/4" FLY NUT	1	
4	XDF.OTT.006	DADO AD ALETTE IN OTTONE M6	WING NUT M6	2	
5	XRP.006.000I	RONDELLA PIANA D. 6 INOX	INOX WASHER D.6	2	
6	XOR.002.062	OR D.15.6X1.78	D.15.6X1.78 OR	2	
7	X02.148.000	DISCO ROTANTE PER REGOLATORE	REGULATOR DISK	1	
8	XTE.006.030I	VITE TE M6X30 INOX	INOX M6X30 BOLT	2	
9	X02.147.500	COPPIA DI SEMICORPO REGOLATORE	REGULATOR HALF-BODY	1	
10	XOR.003.050	OR D.12.37x2.62	O-RING D.12.37x2.62	1	

X02.008.304C

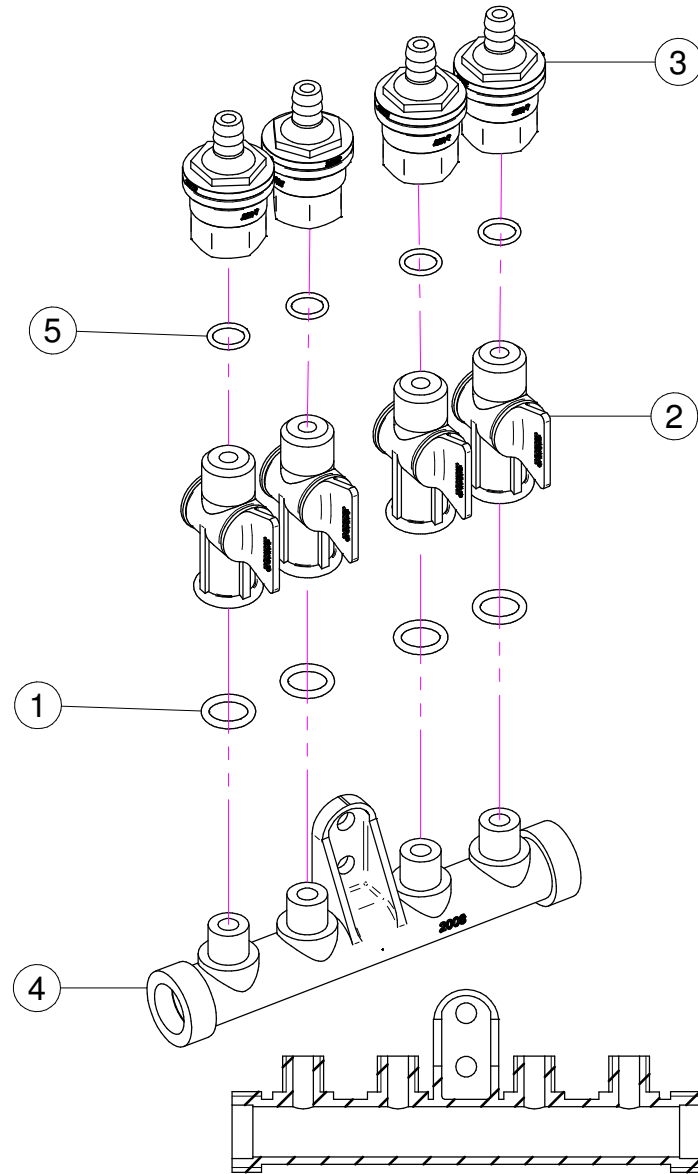

X02.008.404C

DISTRIBUTORE DIVISO
DIVIDED MANIFOLD

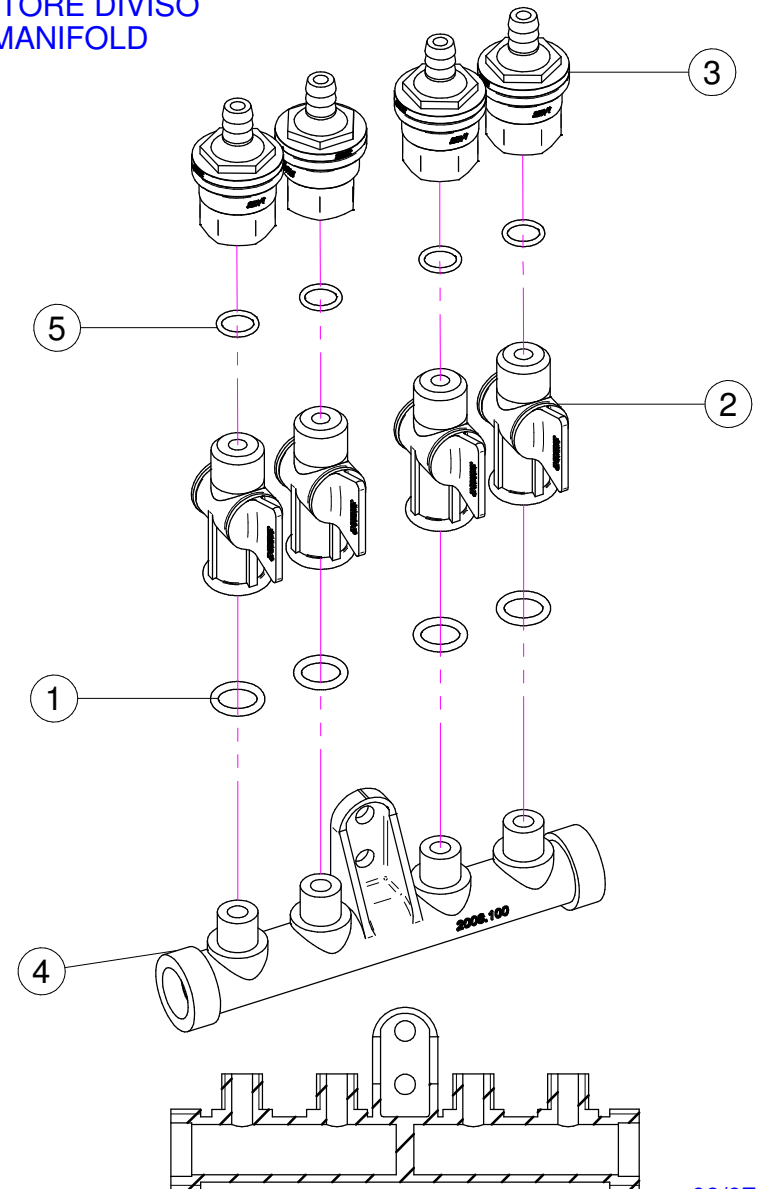

X02.008.304C

N°	Doc. Number	Titolo	Title	Q.tà	Note
1	XOR.000.117	OR D. 13,1x18,34x2,62	13,1x18,34x2;62 O-RING GASKET	4	
2	X20.202.100	RUBINETTO P.G. D.10 F.1/4" GAS TAGLIATO	TAP ASSEMBLY	4	
3	X00.227.01C	DISPOSITIVO ANTIGOCCIA	ANTDRIP VALVE	4	
4	X02.008.000	DISTRIBUTORE LIQUIDO TESTATE	SPRAYHEADS LIQUID MANIFOLD	1	
5	XOR.002.043	OR 10.82X14.38X1.78 NBR70	10.82X14.38X1.78 NBR70 O-RING GASKET	4	

X02.008.404C

N°	Doc. Number	Titolo	Title	Q.tà	Note
1	XOR.000.117	OR D. 13,1x18,34x2,62	13,1x18,34x2;62 O-RING GASKET	4	
2	X20.202.100	RUBINETTO P.G. D.10 F.1/4" GAS TAGLIATO	TAP ASSEMBLY	4	
3	X00.227.01C	DISPOSITIVO ANTIGOCCIA	ANTDRIP VALVE	4	
4	X02.008.100	DISTRIBUTORE LIQUIDO TESTATE DIVISO	DIVIDED SPRAYHEADS LIQUID MANIFOLD	1	
5	XOR.002.043	OR 10.82X14.38X1.78 NBR70	10.82X14.38X1.78 NBR70 O-RING GASKET	4	

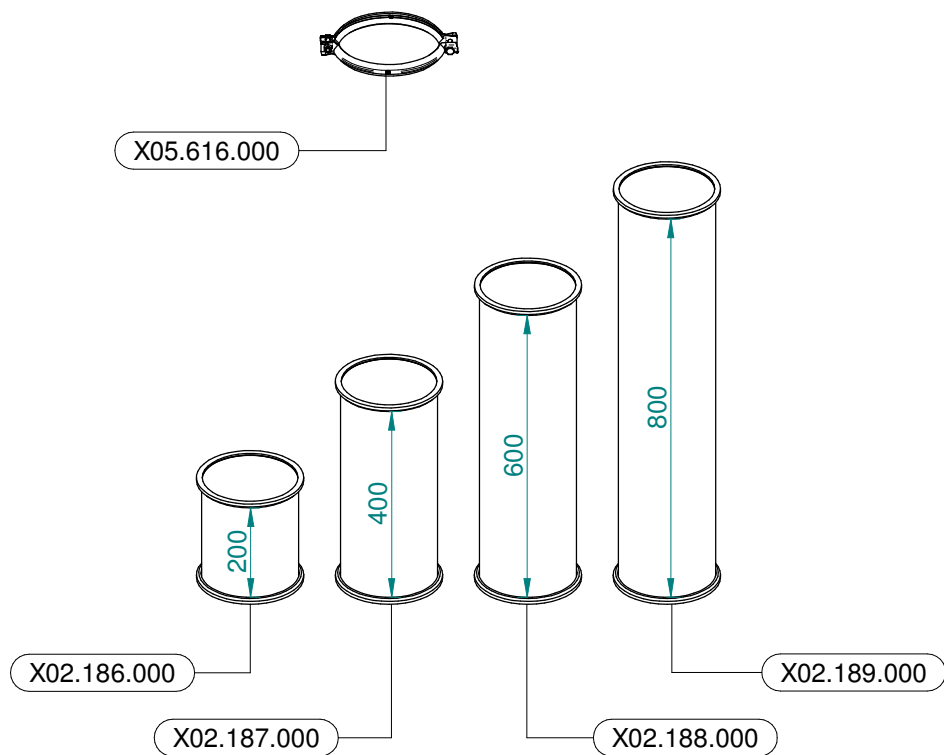

Ø 175
 Plus 42 - 45 - 50
 Blitz 45 - 50
 Link 50

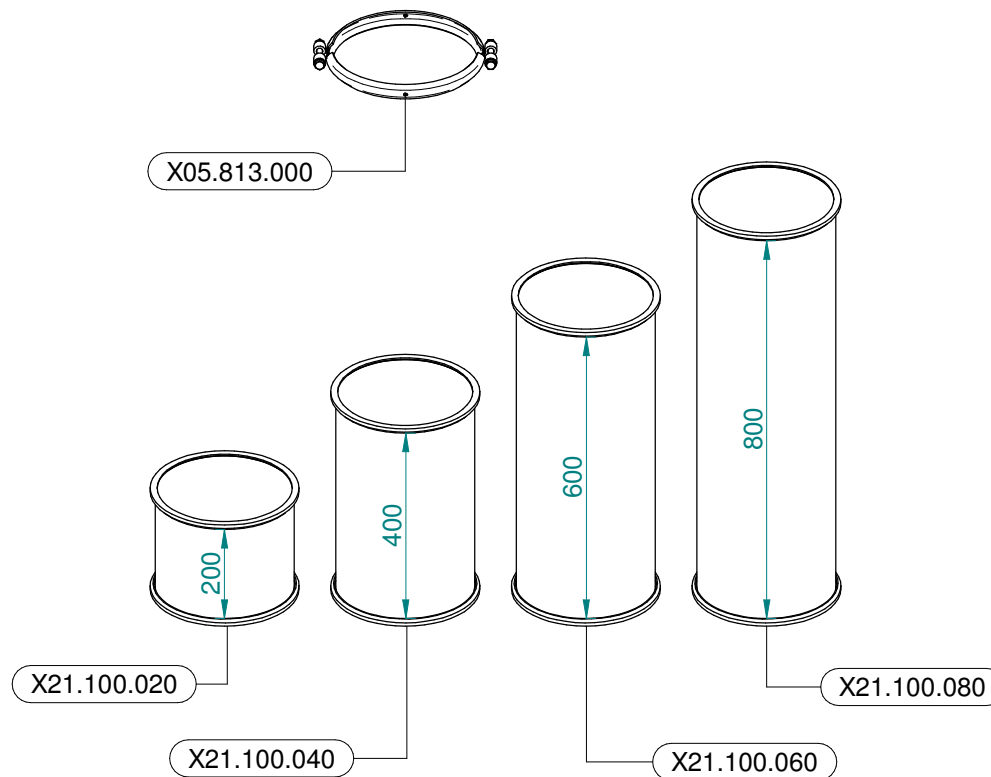

Ø 250
 Plus 55
 Blitz 55
 Link 55