

Plus55

Sez.T06
PERCORSO LIQUIDI
PLUMBING OF LIQUIDS

Sez.T03
PERCORSO ARIA
AIR DUCT

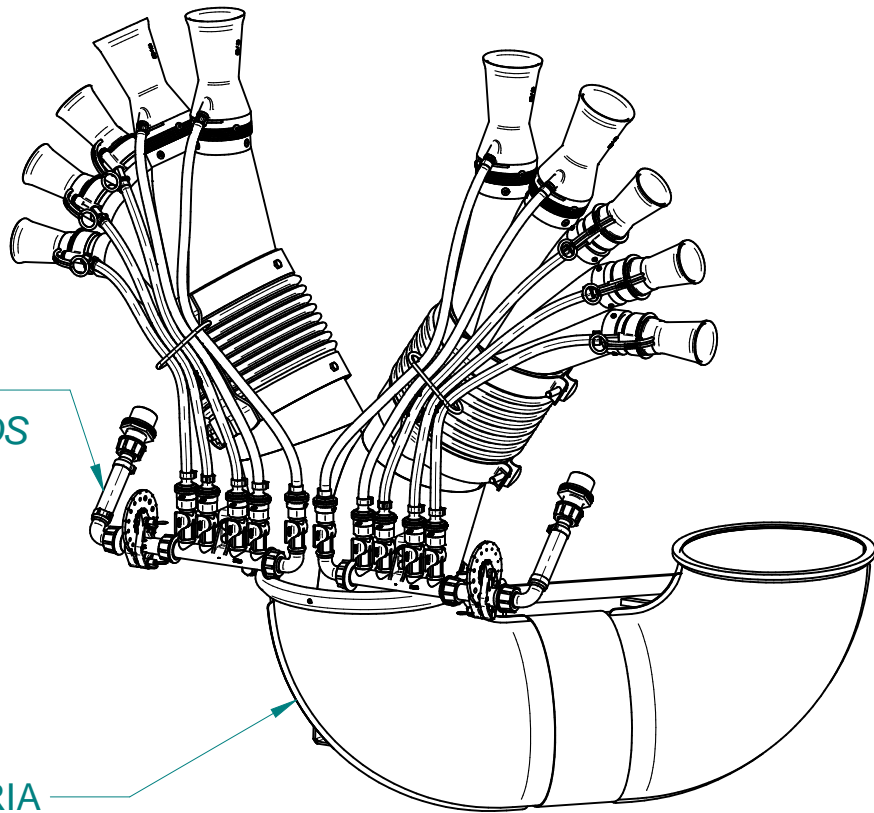

A richiesta - Optional Devices

Sez.T28
PROLUNGHE
Extensions

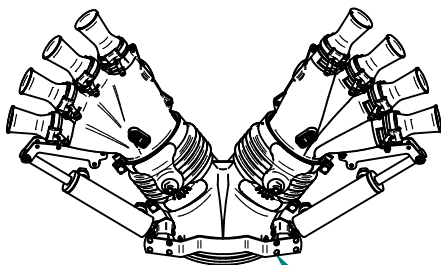

Sez.T26
MOVIMENTAZIONE IDRAULICA
Hydraulic Movement



Plus55

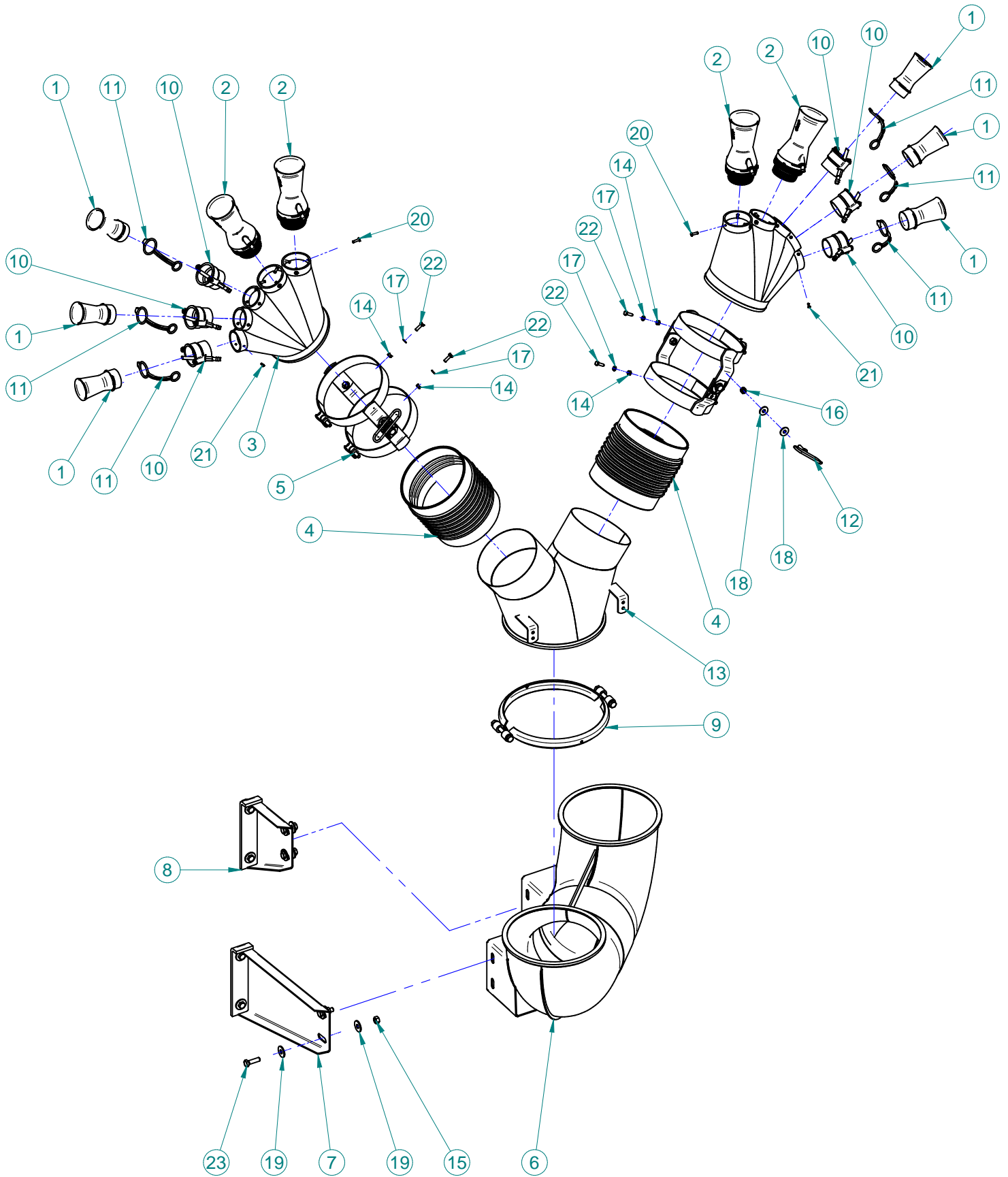

Plus55

N°	Doc. Number	Titolo	Title	Q.tà
1	X00.010.050	DIFFUSORE 10/50	NOZZLE 10/50	6
2	X00.017.065	DIFFUSORE 17/65	17/65 NOZZLE	4
3	X02.125.000	CORPO MANO 5+5.55P	BODY 5+5.55P	2
4	X02.146.010	MANICOTTO FLESSIBILE Ø 180	FLEXIBLE SLEEVE	2
5	X02.804.000	FASCETTA SNODATA	CLAMP	2
6	X05.802.050	CURVA A 180° Ø250	ELBOW 180° Ø250	1
7	X05.802.051	STAFFA FISSAGGIO CURVA D.250 A 180°	ELBOW FIXING BRACKET	1
8	X05.802.151	STAFFA FISSAGGIO CURVA D.250 A 180°	ELBOW FIXING BRACKET	1
9	X05.813.000	COLLARE D.250	250 D. COLLAR	1
10	X20.016.100C	RACCORDO PORTA DIFFUSORE	DIFFUSER FITTING	6
11	X20.697.000	FERMA DIFFUSORE	NOZZLE STOP	6
12	X21.036.000	ANELLO PASSATUBI PER TESTATA OLIVO	CHOCK RING FOR "OLIVE" SPRAYHEAD	2
13	X50.284.000	CORPO D.250 CON 2 USCITE D.180 PER 5+5	BODY D.250 WITH 2 OUTLETS D.175	1
14	XD0.06.5588G	DADO M6 6S PG 5588 ZINC.	M6 6S BIG LEAD NUT 5588	4
15	XD0.10.5587G	DADO M10 6S PG 5587 ZINC.	M10 6S BIG LEAD NUT 5587	8
16	XDA.008.0AG	DADO AUTOBLOCCANTE M8	SELF LOCKING NUT M8	2
17	XRP.006.000	RONDELLA PIANA D.6 6592 ZINC.	6mm D. FLAT WASHER	4
18	XRP.008.024	RONDELLA PIANA F.LARGA D.8X24 ZINC.	WASHER D.8X24	4
19	XRP.010.030	RONDELLA PIANA F.LARGA D.10X30 ZINC.	10X30mm D. LARGE THREAD FLAT	16
20	XRV.4.8.016	RIVETTO 4,8 X 16 MM	RIVET D.4,8 x 16 MM	12
21	XTA.03,5.09,5I	VITE AUTOFILETTANTE D.3,5 x 9,5	SELF THREADING D.3,5 x 9,5	18
22	XTE.006.020T	VITE TE M6X20 5739 ZINC.	BOLT TE M6X20 5739	4
23	XTE.010.035T	VITE TE UNI 5739-65 M10x35-8.8	SCREW TE UNI 5739-65 M10x35-8.8	8

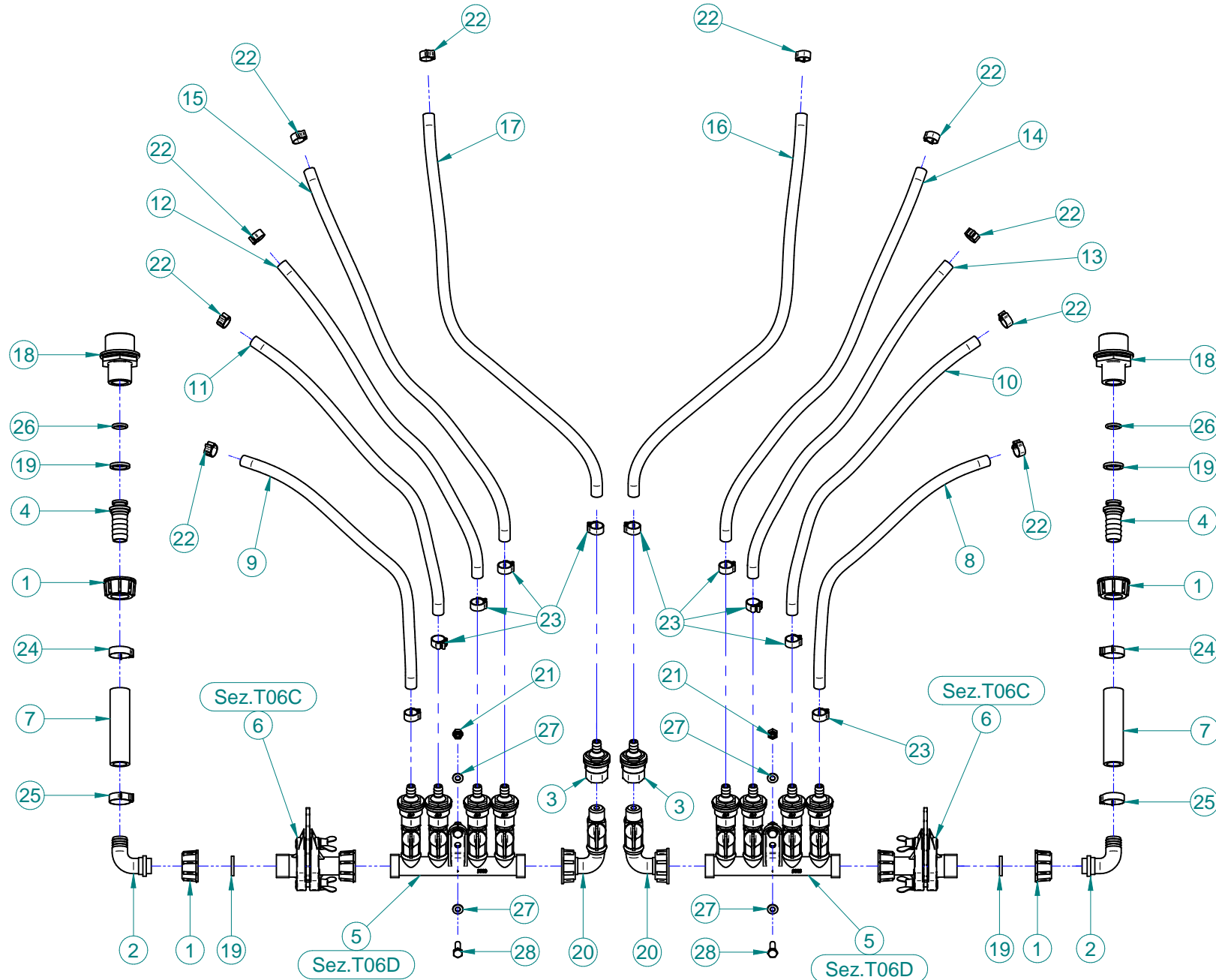

N°	Doc. Number	Titolo	Title	Q.tà
1	X00.055.045	GIRELLO 3/4" GAS ALTO	3/4" GAS FLY NUT	4
2	X00.055.046	RACCORDO CURVO P.G. Ø17	CURVED UNION WITH R.H. Ø17	2
3	X00.227.01C	DISPOSITIVO ANTIGOCCIA	ANTI DRIP DEVICE	2
4	X02.002.000	RACCORDO DIRITTO 3/4" P.G.16	STRAIGHT UNION 3/4" R.H.16	2
5	X02.008.304C	DISTRIBUTORE LIQUIDI A 4 RUBINETTI CON ANTIGOCCIA	FOUR TAPS LIQUID DISTRIBUTOR WITH ANTI-DRIP DEVICE	2
6	X02.150.000	REGOLATORE A DISCO ROTANTE COMPLETO	ROTATION DISK REGULATION	2
7	X02.211.010	TUBO Ø16x23 L=100	HOSE Ø16x23 L=100	2
8	X02.217.037	TUBO D.8X13 L=370	HOSE D.8X13 L=370	1
9	X02.217.037	TUBO D.8X13 L=370	HOSE D.8X13 L=370	1
10	X02.217.042	TUBO D.8X13 L=420	HOSE D.8X13 L=420	1
11	X02.217.042	TUBO D.8X13 L=420	TUBO D.8X13 L=420	1
12	X02.217.047	TUBO D.8X13 L=470	HOSE D.8X13 L=470	1
13	X02.217.047	TUBO D.8X13 L=470	HOSE D.8X13 L=470	1
14	X02.217.052	TUBO D.8X13 L=520	HOSE D.8X13 L=520	1
15	X02.217.052	TUBO D.8X13 L=520	HOSE D.8X13 L=520	1
16	X02.217.056	TUBO D.8X13 L=560	HOSE Ø8x13 L=560	1
17	X02.217.056	TUBO D.8X13 L=560	HOSE Ø8x13 L=560	1
18	X02.293.000	RIDUZIONE 1" M - 3/4" M	1" M - 3/4" M REDUCER NIPPLE	2
19	X02.349.000	GUARNIZIONE PIANA D.17X23X3	17X23X3 FLAT GASKET (G4000B)	6
20	X20.202.102C	RUBINETTO 1/4"F CON CURVA	TAP ASSEMBLY WITH ELBOW	2
21	XD0.06.5588G	DADO M6 6S PG 5588 ZINC.	M6 6S BIG LEAD NUT 5588	4
22	XFC.012,5.014	FASCETTA COBRA SLO30705	KOBRA CLAMP	10
23	XFC.013,5.015	FASCETTA COBRA 13/8 W4	CLAMP D.13,5-15	10
24	XFC.022,5.024	FASCETTA COBRA 22,5 - 24	KOBRA CLAMP 22,5 - 24	2
25	XFC.024,5.026	FASCETTA COBRA 24,5 - 26	KOBRA CLAMP 24,5 - 26	2
26	XOR.000.117	OR D.13,1X2,62	13.1X2.62 O-RING GASKET	2
27	XRP.006.000	RONDELLA PIANA D.6 6592 ZINC.	6mm D. FLAT WASHER	8
28	XTE.006.020T	VITE TE M6X20 5739 ZINC.	BOLT TE M6X20 5739	4

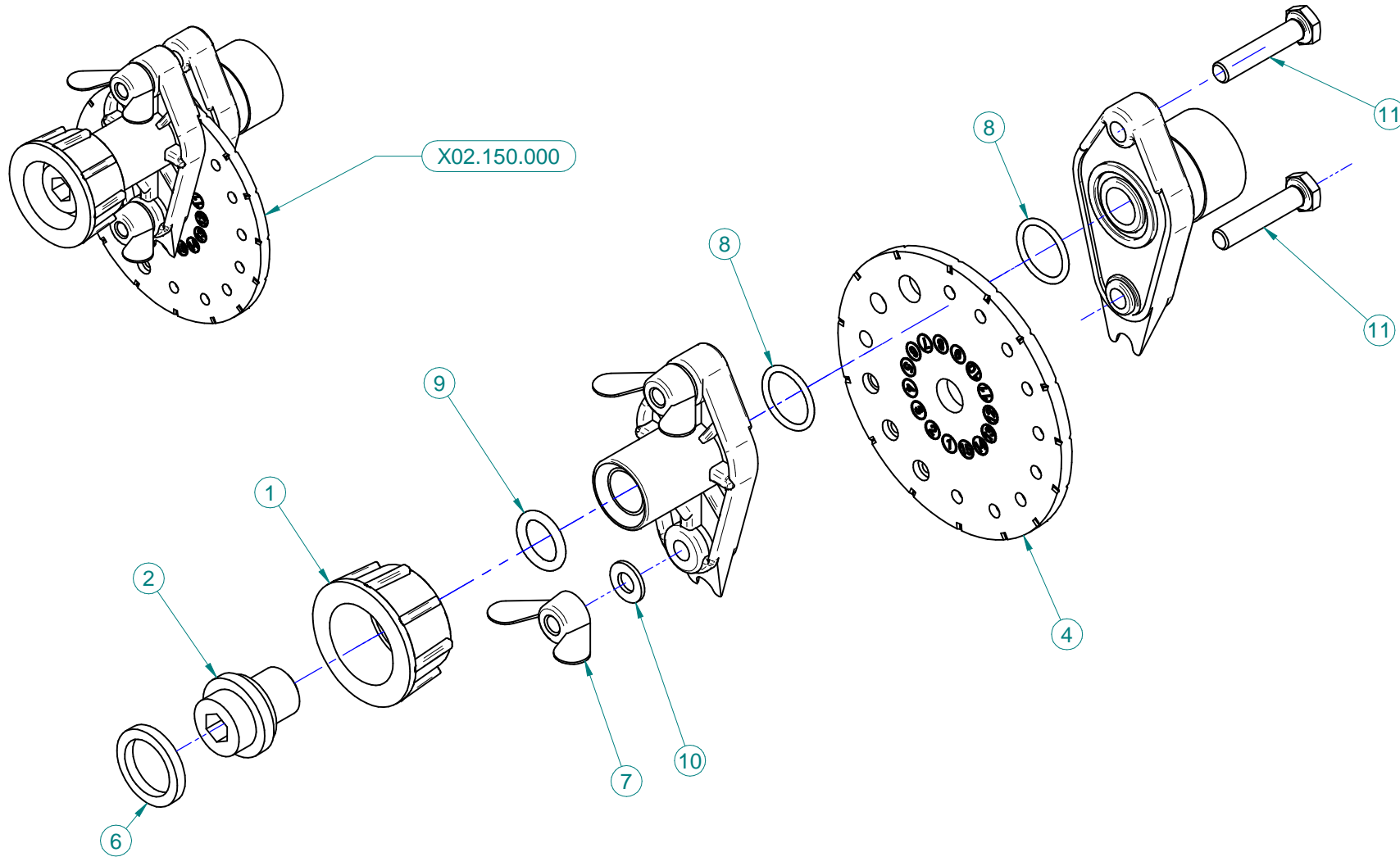

N°	Codice	Titolo	Title	Q.tà
1	X00.055.045	GIRELLO 3/4" GAS ALTO	3/4" GAS FLY NUT	1
2	X02.117.000	NIPPLO M14X1,5/D.17	14MX1.5 17 D. NIPPLE	1
3*	X02.147.000	SEMICORPO DEL REGOLATORE	REGULATOR SEMIBODY	1
4	X02.148.000	DISCO ROTANTE PER REGOLATORE	REGULATOR DISK	1
5*	X02.149.000	SEMICORPO DEL REGOLATORE	COUPLING	1
6	X02.349.000	GUARNIZIONE PIANA D.17X23X3	17X23X3 FLAT GASKET (G4000B)	1
7	XDF.OTT.006	DADO AD ALETTE IN OTTONE M6	BRASS M6 WING NUT	2
8	XOR.002.062	OR D.15,6X1,78	15.6X1.78 O-RING GASKET	2
9	XOR.003.050	OR D.12,37X2,62	O-RING Ø 12,37x2,62	1
10	XRP.006.00I	RONDELLA PIANA D.6 INOX	WASHER D.6	2
11	XTE.006.030I	VITE TE M6X30 INOX 5739	BOLT TE M6X30 STAINLESS STEEL 5739	2

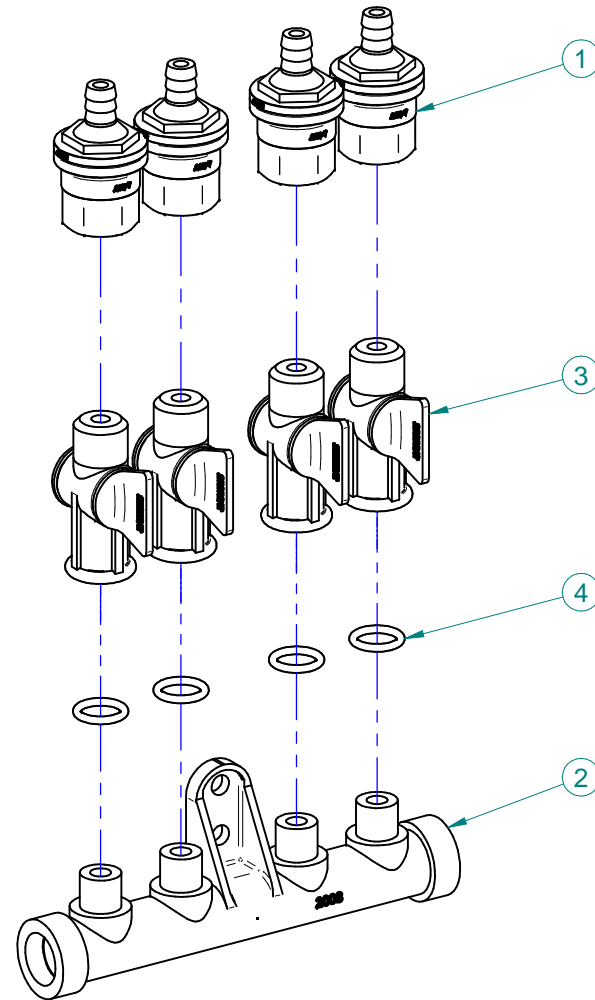
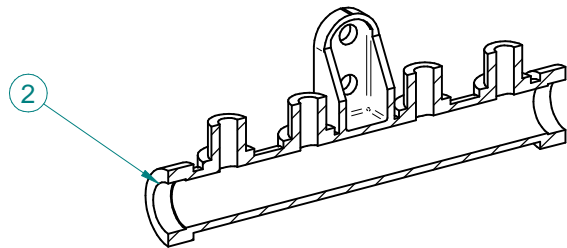

N°	Doc. Number	Titolo	Title	Q.tà
1	X00.227.01C	DISPOSITIVO ANTIGOCCIA	ANTI DRIP DEVICE	4
2	X02.008.000	DISTRIBUTORE LIQUIDO TESTATE	SPRAYHEADS LIQUID DISTRIBUTOR	1
3	X20.202.100	RUBINETTO F.1/4" M.18X1,5	TAP ASSEMBLY	4
4	XOR.000.117	OR D.13,1X2,62	13.1X2.62 O-RING GASKET	4